

EC POWER A/S

SAMSØVEJ 25
 DK- 8382 HINNERUP
 TEL. +45 87 434 100
 WWW.ECPOWER.EU



XRGI CONTROL PANEL XRGI STROMLAUFPLAN

20KW GENERATOR (iQ20)
 17ELD1010

WITH MEGACON PHASE MONITORING
 MIT MEGACON PHASEN MONITORING

DRAW NO. 52756T05	THIS DRAWING MAY NOT BE COPIED OR DISCLOSED TO A THIRD PARTY WITHOUT OUR PERMISSION		Print date	21-10-2013	XRGI CONTROL PANEL / STEUERSCHRANK FRONT PAGE / DECKBLATT	PROJECT	FILENAME:17ELD1010 - 52756T05 - 20kw UK
	EC POWER A/S Samsøvej 25 DK - 8382 Hinnerup						DRAWING NO.
		JHS	02-10-2013	52756T05			
	OPR.	JHS	17-12-2010				PAGE:0

TABLE OF CONTENTS / INHALTSVERZEICHNIS

DRAWING NO. ZEICHNUNG NR.	PAGE SEITE	FUNCTION TEXT BEZEICHNUNG	CONST. KONSTR.	DRAWING DATE ZEICHNUNGSDATUM	REV. REV.	REV. DATE REV. DATUM
52756T05	IND(1.A)	REVISIONS LIST /REVISIONSLISTE	JHS	17-12-2010		06-10-2013
	1	TECHNICAL DATA / TECHNISCHE DATEN	JHS	11-08-2008		07-04-2011
	2	MOUNTING PLATE & FRONT LAYOUT / ANSICHT & AUFBAU	JHS	11-08-2008		06-10-2013
	3	DOOR BACK SIDE LAYOUT / RÜCKSEITE SCHALTSCHRANKTÜRE	JHS	11-08-2008		02-10-2013
	4	MAIN SUPPLY / EINSPEISUNG	JHS	11-08-2008		02-10-2013
	5	GENERATOR / GENERATOR	JHS	11-08-2008		06-10-2013
	6	PHASE MONITORING/ PHASEN MONITORING	JHS	11-08-2008		02-10-2013
	7	POWER SUPPLY CONTROL CIRCUIT/ STROMVERSORGUNG STEUERUNG	JHS	11-08-2008		02-10-2013
	8	POWER SUPPLY / STROMVERSORGUNG	JHS	11-08-2008		21-10-2013
	9	MOTHERBOARD Y4-12 INPUT / EINGÄNGE	JHS	11-08-2008		02-10-2013
	10	MOTHERBOARD Y13-21 INPUT / EINGÄNGE	JHS	11-08-2008		02-10-2013
	11	MOTHERBOARD Y22-30 INPUT / EINGÄNGE	JHS	11-08-2008		02-10-2013
	12	MOTHERBOARD Z1-8 OUTPUT / AUSGÄNGE	JHS	11-08-2008		02-10-2013
	13	MOTHERBOARD Z9-16 OUTPUT / AUSGÄNGE	JHS	11-08-2008		06-10-2013
	14	MOTHERBOARD Z17-24 OUTPUT / AUSGÄNGE	JHS	11-08-2008		02-10-2013
	15	MOTHERBOARD Z25-30 OUTPUT / AUSGÄNGE	JHS	11-08-2008		02-10-2013
	17	TERMINAL ROW X2 / KLEMMENREIHE X2	JHS	11-08-2008		02-10-2013
	20	TERMINAL ROW X5 / KLEMMENREIHE X5	JHS	11-08-2008		02-10-2013
	22	TERMINAL ROW X7 / X8 KLEMMENREIHE X7 / X8	JHS	11-08-2008		02-10-2013
	23	TERMINAL ROW X9 / KLEMMENREIHE X9	JHS	15-09-2010		02-10-2013
	24	ALARM CONNECTIONS / ALARM AUSGÄNGE	JHS	11-08-2008		21-10-2013
	25	COMPONENTS LIST / STÜCKLISTE	JHS	11-08-2008		21-10-2013

REVISIONS LIST / REVISIONSLISTE

REV.	DATE DATO	PAGE SEITE	DESCRIPTION BESCHREIBUNG
01	12-04-2011		NEW DOCUMENT BASED ON 52533T01
02	15-03-2012	ALL	COMPONENTS UPDATED
03	28-12-2012	7	ADDED FAN
04	28-12-2012		NEW DISPLAY BOARD
05	04-10-2013		PLACEMENT OF SOFTSTARTER AND CONTACTOR CHANGED. KONDENSATOR ADDED TO THE FAN X1 / X3 / X4 / X6 REMOVED
05	04-10-2013		X8 ADDED TRANSIENT PROTECTION ADDED SOFTSTARTER UPDATED
05	04-10-2013		Z19 USED TO K12 K5 MOVED ELECTRICAL K11 NEW TEXT

ELECTRIC DATA / ELEKTRISCHE DATEN

POWER SUPPLY / STROMVERSORGUNG : 3X400VAC+N+PE
 FREQUENCY / NETZFREQUENZ : 50 Hz
 CONTROL VOLTAGE / STEUERSPANNUNG : 24VDC
 MAX. SWITCHBOARD LOAD / MAX. SCHALTSCHRANKBELASTUNG : 40 A
 SUPPLY LINE FUSE / VORSICHERUNG : MIN 50A MAX 63A gL
 SYSTEM EARTHING / NETZSYSTEM : TN-S/TT
 MAX. SWITCHBOARD TEMP. / MAX. SCHALTSCHRANKTEMP. : 40° C
 GRADE OF PROTECTION / SCHUTZART : IP54
 YEAR OF CONSTRUCTION / BAUJAHR : 2011
 NORM / NORM : EN60439-1 / EN60204-1

WIRE COLOUR CODE / ADERNFARBEN

POWER CIRCUITS / HAUPTSTROMKREIS : BLACK / SCHWARZ
 NEUTRAL / NEUTRALLEITER : LIGHT BLUE / HELLBLAU
 PROTECTIVE EARTH / SCHUTZLEITER : GREEN/YELLOW / GELB/GRÜN
 INTERLOCKING AC/DC CIRCUITS AND EXTERNALLY SUPPLIED CIRCUITS / VERRIEGELNDE AC/DC SCHALTUNGEN UND EXTERNE SCHALTUNGEN : ORANGE / ORANGE
 CONTROL CIRCUITS ABOVE 50 V / STEUERSTROMKREISE ÜBER 50 V
 PHASE AC / PHASE AC : BLACK / SCHWARZ
 NEUTRAL AC / NEUTRALLEITER AC : LIGHT BLUE / HELLBLAU
 CONTROL CIRCUITS BELOW 50 V / STEUERSTROMKREISE UNTER 50 V
 PHASE AC / PHASE AC : RED / ROT
 NEUTRAL AC / NEUTRALLEITER AC : GREY / GRAU
 DC+ / DC+ : DARK BLUE / DUNKELBLAU
 0V DC / 0VDC : WHITE / WEIß

WARNING

WHEN DISCONNECTING THE CONTROL PANEL MAIN SWITCH, ITS INPUT-TERMINALS ARE STILL SUPPLIED

THE CONTROL PANEL IS TO BE OPENED BY AUTHORIZED PERSONAL ONLY

ACHTUNG

AUCH BEI AUSGESCHALTETEM HAUPTSCHALTER SIND DIE EINGEBAUTEN GERÄTE NOCH UNTER SPANNUNG

DER SCHALTSCHRANK DARF NUR VON AUTORISIERTEN PERSONEN GEÖFFNET WERDEN

FUSES / SICHERUNGEN

FUSES: THE COMPLETE CURRENT ΣAMP FOR ALL OUTPUTS ARE LIMITED TO 1 AMP.
 SICHERUNGEN: DER GESAMTE SUMMENSTROM ΣAMP FÜR ALLE AUSGÄNGE IST AUF 1 AMP. BEGRENZT

COMP. NO BEZEICHNUNG	FUNCTION / FUNKTION	TYPE / TYP
F1	24VDC INTERNAL FOR DISPLAY CARD (-D2) 24VDC INTERN FÜR DISPLAYKARTE (-D2)	1, 6A
F2	24VDC INTERNAL FOR MOTHERBOARD (-D1) 24VDC INTERN FÜR MOTHERBOARD (-D1)	2, 0A
F3	5VDC INTERNAL FOR DISPLAY CARD (-D2) 5VDC INTERN FÜR DISPLAYKARTE (-D2)	2, 0A
F4	5VDC INTERNAL FOR MOTHERBOARD (-D1) 5VDC INTERN FÜR MOTHERBOARD (-D1)	1, 6A

COLOUR CODE ACCORDING TO IEC 757 /
 FARBCODE ENTSPRECHEND IEC 757

WIRE COLOUR / KABEL FARBE	CODE / CODE	WIRE COLOUR / KABEL FARBE	CODE / CODE
BLACK / SCHWARZ	BK	VIOLET / VIOLET	VT
BROWN / BRAUN	BN	GREY / GRAU	GY
RED / ROT	RD	WHITE / WEIß	WH
ORANGE / ORANGE	OG	PINK / PINK	PK
YELLOW / GELB	YE	GOLD / GOLD	GD
GREEN / GRÜN	GN	TURQUISE / TÜRKIS	TQ
BLUE / BLAU	BU	SILVER / SILBER	SR
GREEN-YELLOW / GELB GRÜN	GNYE		

DRAWING NO.
52756T05

THIS DRAWING MAY NOT BE COPIED OR DISCLOSED TO A THIRD PARTY WITHOUT OUR PERMISSION

EC POWER A/S
 Samsøvej 25
 DK - 8382 Hinnerup

Print date	21-10-2013
JHS	07-04-2011
OPR. JHS	17-12-2010

XRGI CONTROL PANEL / STEUERSCHRANK
 TECHNICAL DATA / TECHNISCHE DATEN

PROJECT

FILENAME:17ELD1010 - 52756T05 - 2013 UK

DRAWING NO.

52756T05

PAGE:1

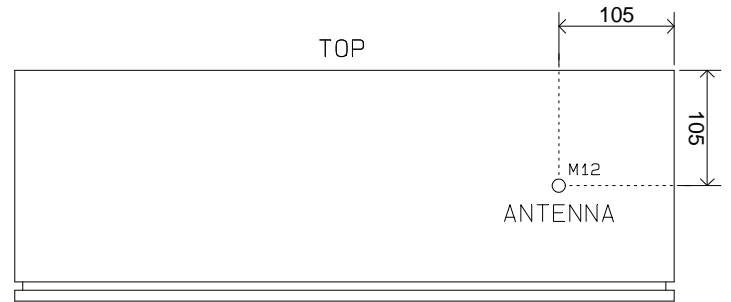
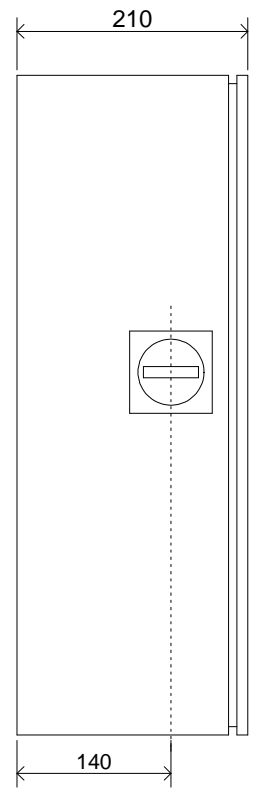
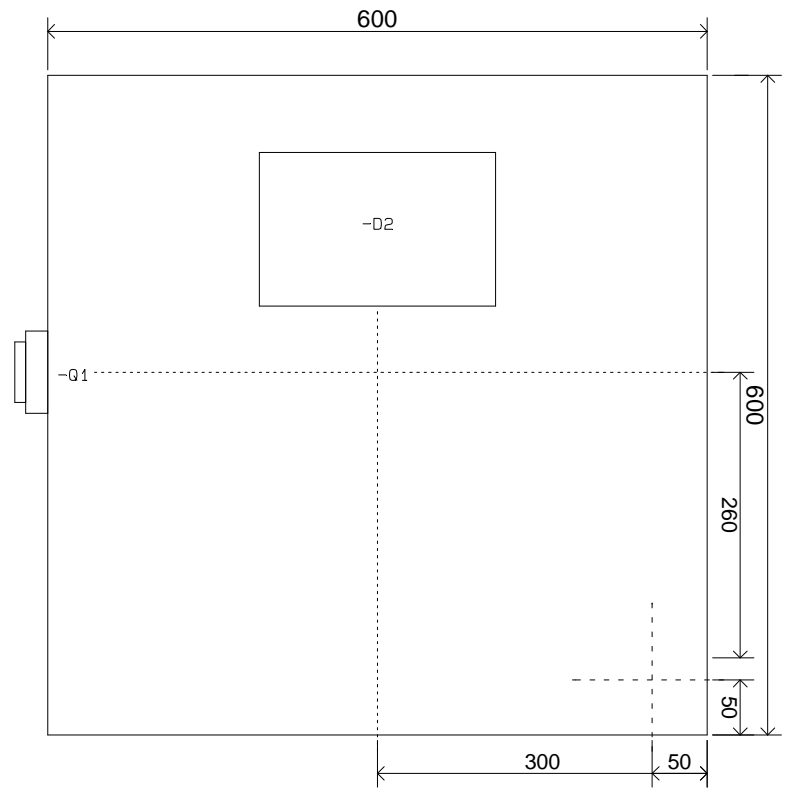
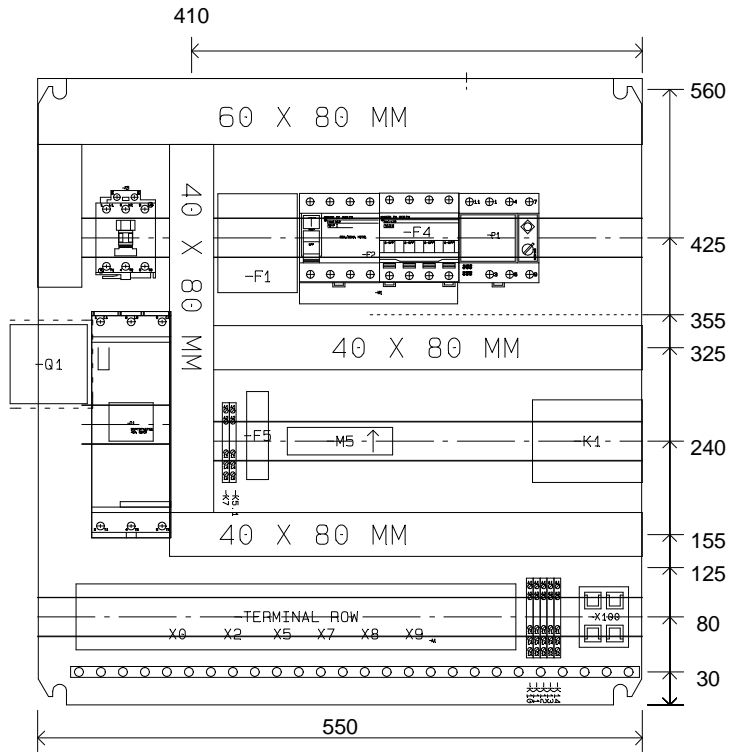

DRAW NO.
52756T05

THIS DRAWING MAY NOT BE COPIED OR DISCLOSED TO A THIRD PARTY WITHOUT OUR PERMISSION

EC POWER A/S
Samsøvej 25
DK - 8382 Hinnerup

Print date	21-10-2013
JHS	06-10-2013
OPR. JHS	17-12-2010

XRGI CONTROL PANEL / STEUERSCHRANK
MOUNTING PLATE & FRONT LAYOUT /
ANSICHT & AUFBAU

PROJECT

FILENAME:17ELD1010 - 52756T05 - 20kw UK
DRAWING NO.
52756T05

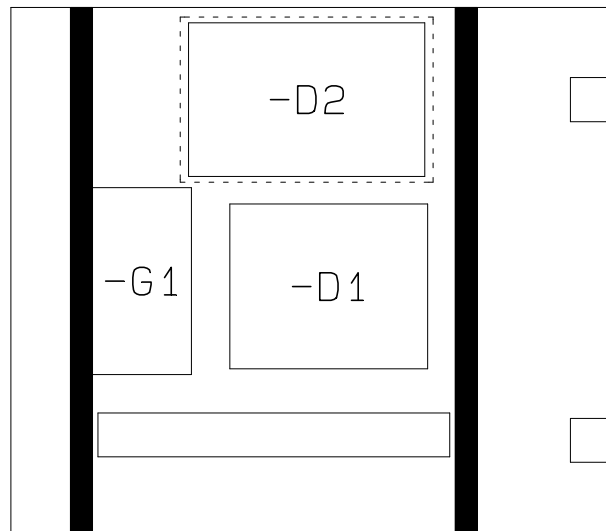

Print date	21-10-2013
OPR.	JHS 17-12-2010

POWER DIRECTION LOADED GENERATOR / LEISTUNGSRICHTUNG DES GENERATORBETRIEBES

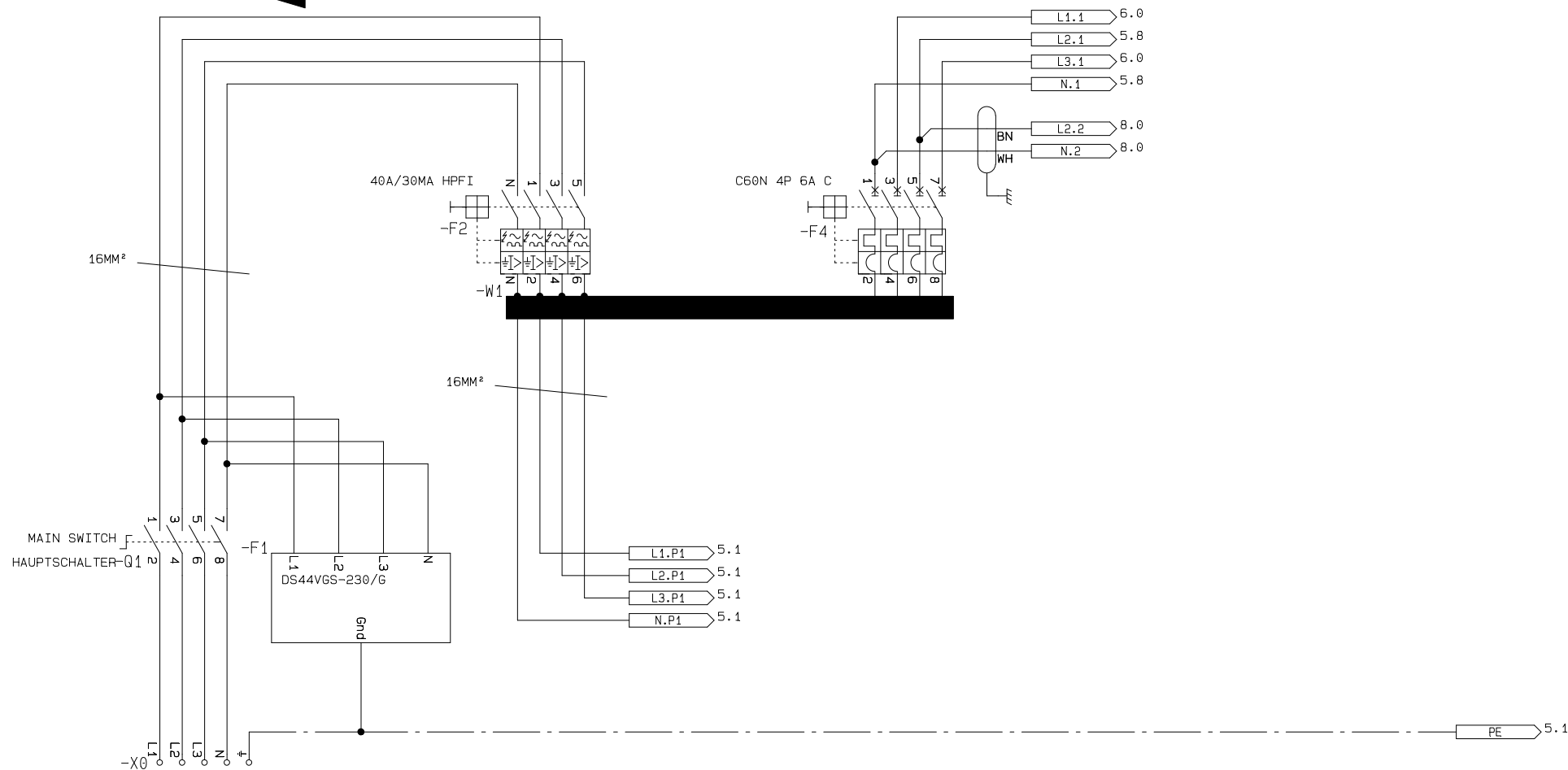

POWER DIRECTION LOADED GENERATOR / LEISTUNGSRICHTUNG DES GENERATORBETRIEBES

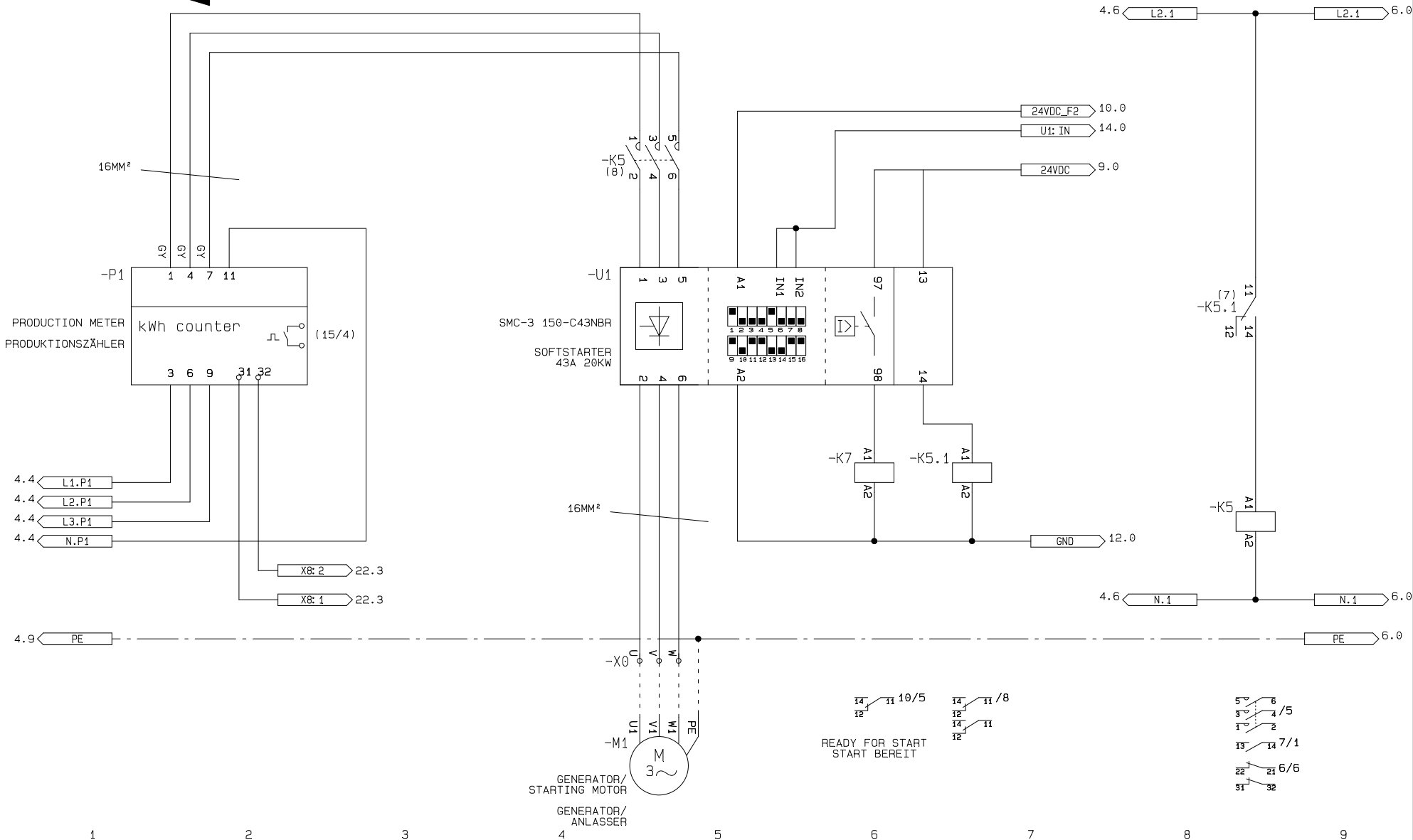

DRAW NO.
52756T05

THIS DRAWING MAY NOT BE COPIED OR DISCLOSED TO A THIRD PARTY WITHOUT OUR PERMISSION

EC POWER A/S
Samsøvej 25
DK - 8382 Hinnerup

Print date	21-10-2013
JHS	06-10-2013
OPR. JHS	17-12-2010

XRGI CONTROL PANEL / STEUERSCHRANK
GENERATOR / GENERATOR

PROJECT

FILENAME:17ELD1010 - 52756T05 - 20kw UK
DRAWING NO.

52756T05

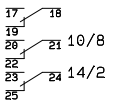
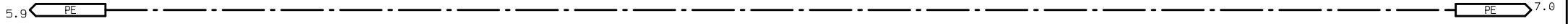
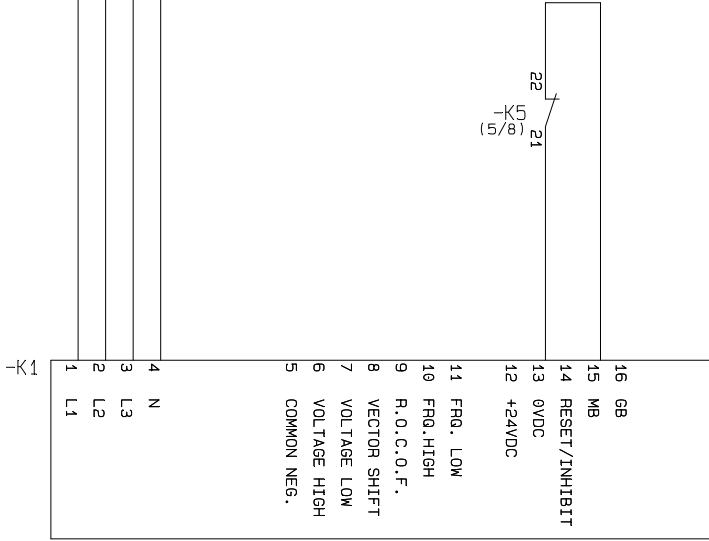
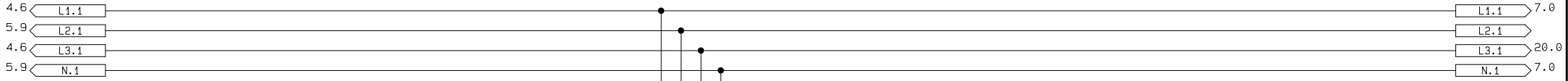

DRAW. NO.
52756T05

THIS DRAWING MAY NOT BE COPIED OR DISCLOSED TO A THIRD PARTY WITHOUT OUR PERMISSION
EC POWER A/S
 Samsøvej 25
 DK - 8382 Hinnerup

Print date	21-10-2013
JHS	02-10-2013
OPR. JHS	17-12-2010

XRGI CONTROL PANEL / STEUERSCHRANK
 PHASE MONITORING/
 PHASEN MONITORING

PROJECT

FILENAME:17ELD1010 - 52756T05 - 20kw UK
 DRAWING NO.
52756T05
 PAGE:6



DRAW NO.
52756T05

THIS DRAWING MAY NOT BE COPIED OR DISCLOSED TO A THIRD PARTY WITHOUT OUR PERMISSION

EC POWER A/S
Samsøvej 25
DK - 8382 Hinnerup

Print date	21-10-2013
JHS	02-10-2013
OPR. JHS	17-12-2010

XRGI CONTROL PANEL / STEUERSCHRANK
POWER SUPPLY CONTROL CIRCUIT/
STROMVERSORGUNG STEUERUNG

PROJECT

FILENAME:17ELD1010 - 52756T05 - 20kw UK
DRAWING NO.
52756T05
PAGE:7

4.6 L2.2
 4.6 N.2
 7.9 PE

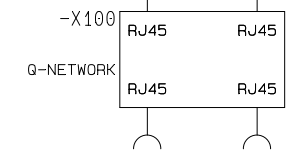
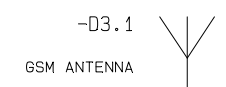
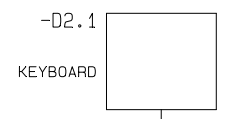
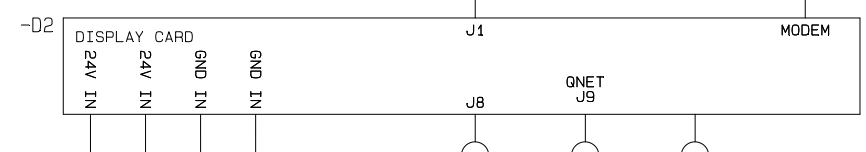
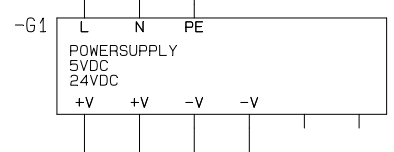
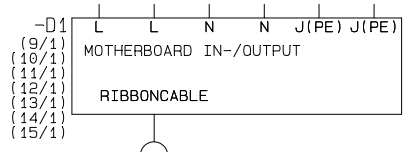

DRAW NO.
 52756T05

THIS DRAWING MAY NOT BE COPIED OR DISCLOSED TO A THIRD PARTY WITHOUT OUR PERMISSION
EC POWER A/S
 Samsøvej 25
 DK - 8382 Hinnerup

Print date	21-10-2013
JHS	21-10-2013
OPR. JHS	17-12-2010

XRGI CONTROL PANEL / STEUERSCHRANK
 POWER SUPPLY /
 STROMVERSORGUNG

PROJECT

FILENAME:17ELD1010 - 52756T05 - 20kw UK
 DRAWING NO.
52756T05

PAGE:8

-01
(8/0)

MOTHERBOARD IN-/OUTPUT

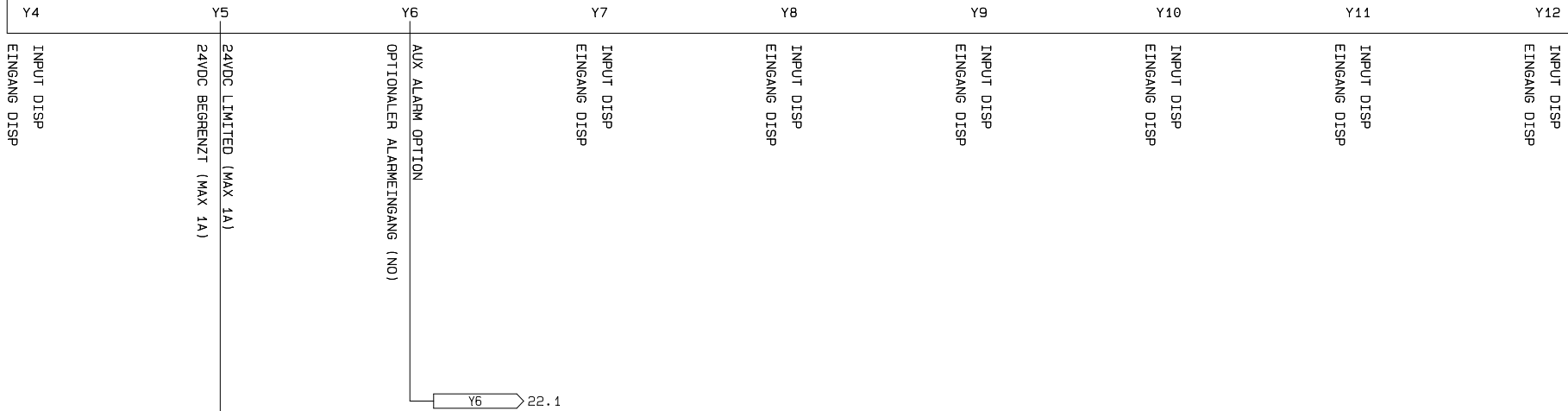

5.7 < 24VDC

24VDC > 10.0

THIS DRAWING MAY NOT BE COPIED OR DISCLOSED TO A THIRD PARTY WITHOUT OUR PERMISSION

EC POWER A/S
Samsøvej 25
DK - 8382 Hinnerup

Print date	21-10-2013
JHS	02-10-2013
OPR. JHS	17-12-2010

XRGI CONTROL PANEL / STEUERSCHRANK
MOTHERBOARD Y4-12
INPUT / EINGÄNGE

PROJECT

FILENAME:17ELD1010 - 52756T05 - 20kw UK
DRAWING NO.

52756T05

-01
(8/0)

MOTHERBOARD IN-/OUTPUT

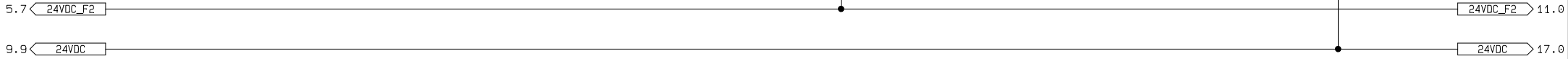
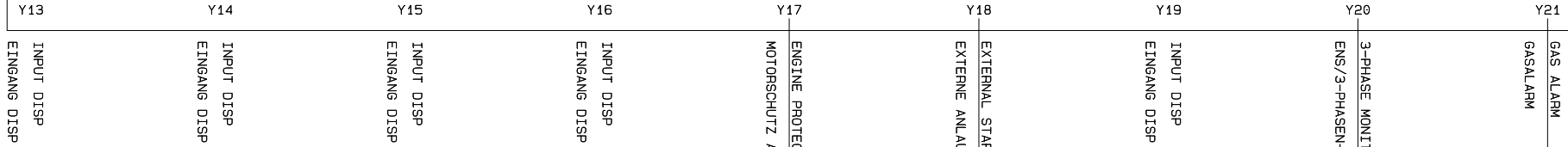

DRAW NO.
52756T05

THIS DRAWING MAY NOT BE COPIED OR DISCLOSED TO A THIRD PARTY WITHOUT OUR PERMISSION

EC POWER A/S
Samsøvej 25
DK - 8382 Hinnerup

Print date	21-10-2013
JHS	02-10-2013
OPR. JHS	17-12-2010

XRGI CONTROL PANEL / STEUERSCHRANK
MOTHERBOARD Y13-21
INPUT / EINGÄNGE

PROJECT

FILENAME:17ELD1010 - 52756T05 - 20kw UK
DRAWING NO.

52756T05

-01
(8/0)

MOTHERBOARD IN-/OUTPUT

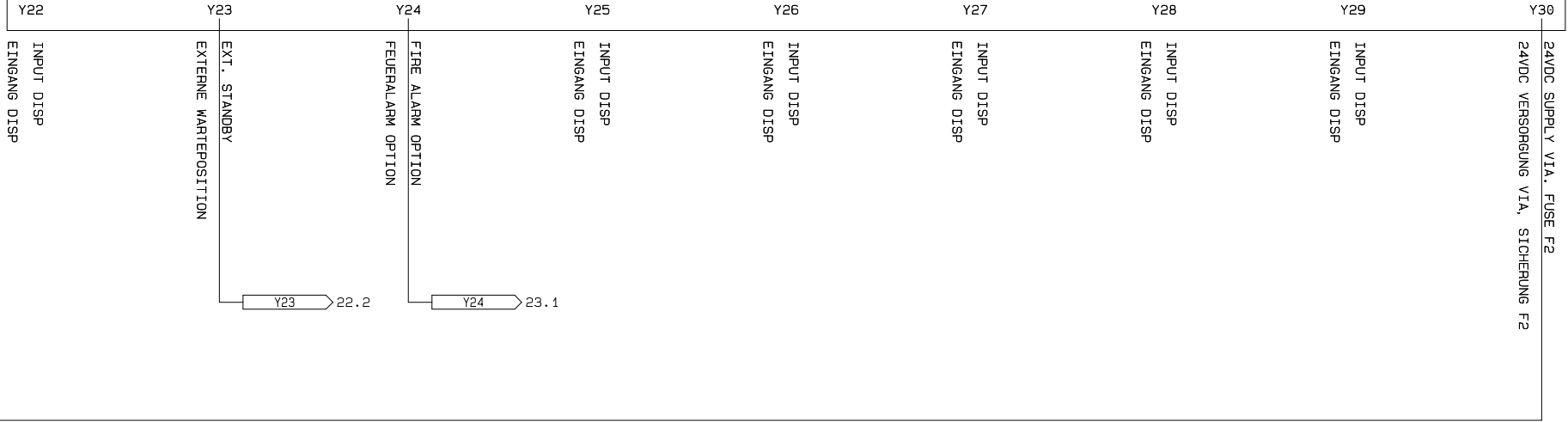

10.9 < 24VDC_F2

THIS DRAWING MAY NOT BE COPIED OR DISCLOSED TO A THIRD PARTY WITHOUT OUR PERMISSION

EC POWER A/S
Samsøvej 25
DK - 8382 Hinnerup

Print date	21-10-2013
JHS	02-10-2013
OPR. JHS	17-12-2010

XRGI CONTROL PANEL / STEUERSCHRANK
MOTHERBOARD Y22-30
INPUT / EINGÄNGE

PROJECT

FILENAME:17ELD1010 - 52756T05 - 20kw UK
DRAWING NO.
52756T05
PAGE:11

DRAW NO.
52756T05

-01
(8/0)

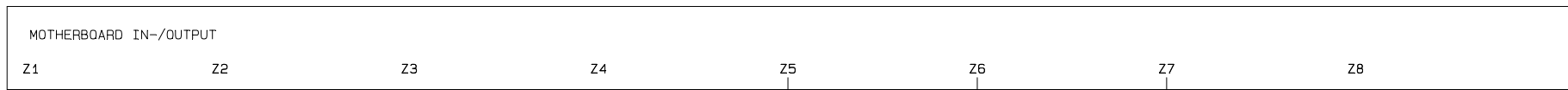

OUTPUT DISP
AUSGANG DISP

OUTPUT DISP
AUSGANG DISP

OUTPUT DISP
AUSGANG DISP

OUTPUT DISP
AUSGANG DISP

HEAT PUMP 2
WÄRMEPUMPE 2

24V GND

BETRIEB
RUNNING

OUTPUT DISP
AUSGANG DISP



THIS DRAWING MAY NOT BE COPIED OR DISCLOSED TO A THIRD PARTY WITHOUT OUR PERMISSION

EC POWER A/S
Samsøvej 25
DK - 8382 Hinnerup

Print date	21-10-2013
JHS	02-10-2013
OPR. JHS	17-12-2010

XRGI CONTROL PANEL / STEUERSCHRANK

MOTHERBOARD Z1-8
OUTPUT / AUSGÄNGE

PROJECT

FILENAME:17ELD1010 - 52756T05 - 20kw UK
DRAWING NO.
52756T05
PAGE:12

DRAW NO.
52756T05

-01
(0/0)

MOTHERBOARD IN-/OUTPUT

Z9

Z10

Z11

Z12

Z13

Z14

Z15

Z16

OUTPUT DISP
AUSGANG DISP

OUTPUT DISP
AUSGANG DISP

OUTPUT DISP
AUSGANG DISP

OUTPUT DISP
AUSGANG DISP

OUTPUT DISP
AUSGANG DISP

OUTPUT DISP
AUSGANG DISP

OUTPUT DISP
AUSGANG DISP

OUTPUT DISP
AUSGANG DISP

12.9 GND

GND 14.0

0

1

2

3

4

5

6

7

8

9

THIS DRAWING MAY NOT BE COPIED OR DISCLOSED TO A THIRD PARTY WITHOUT OUR PERMISSION

EC POWER A/S
Samsøvej 25
DK - 8382 Hinnerup

Print date	21-10-2013
JHS	06-10-2013
OPR. JHS	17-12-2010

XRGI CONTROL PANEL / STEUERSCHRANK
MOTHERBOARD Z9-16
OUTPUT / AUSGÄNGE

PROJECT

FILENAME:17ELD1010 - 52756T05 - 20kw UK
DRAWING NO.
52756T05
PAGE:13

DRAW NO.
52756T05

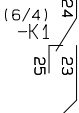
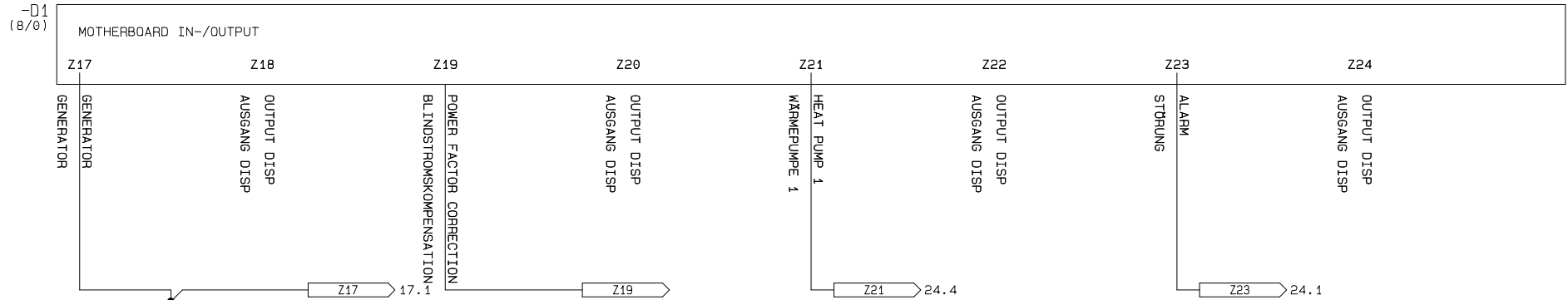

Print date	21-10-2013
JHS	02-10-2013
OPR. JHS	17-12-2010

-D1
(8/0)

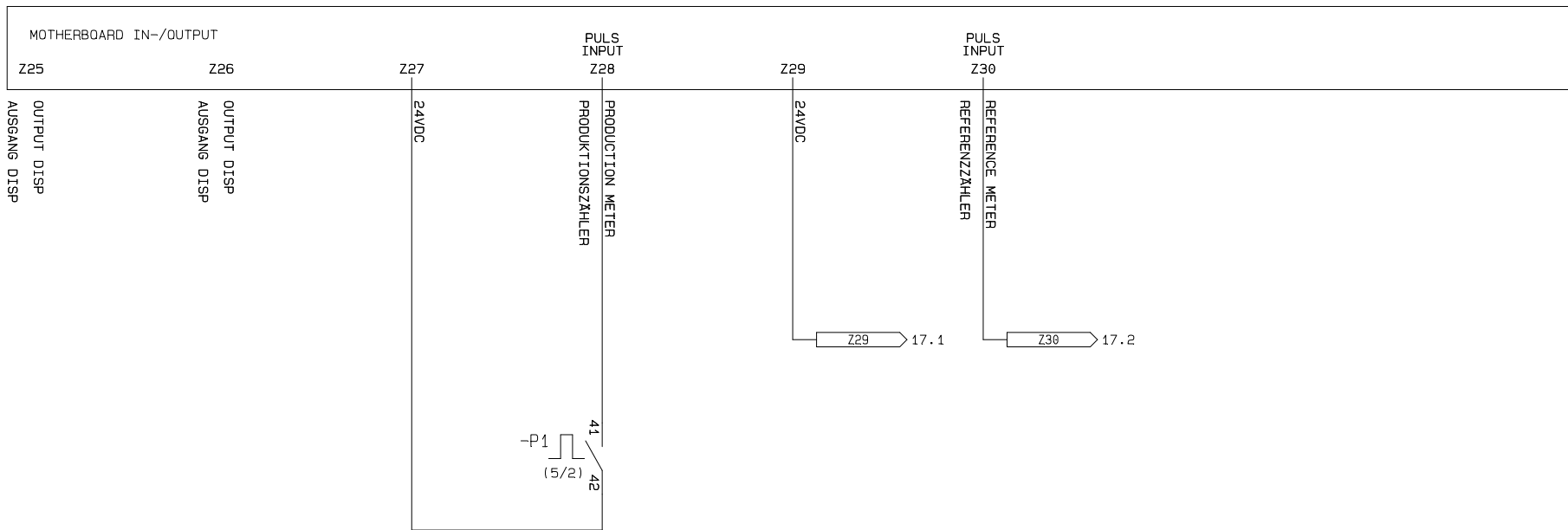

14.9 GND 17.0 GND

DIESEL ONLY
NUR DIESEL

PRODUCTION METER
PRODUKTIONSZÄHLER

0 1 2 3 4 5 6 7 8 9

THIS DRAWING MAY NOT BE COPIED OR DISCLOSED TO A THIRD PARTY WITHOUT OUR PERMISSION

EC POWER A/S
Samsøvej 25
DK - 8382 Hinnerup

Print date	21-10-2013
JHS	02-10-2013
OPR. JHS	17-12-2010

XRGI CONTROL PANEL / STEUERSCHRANK
MOTHERBOARD Z25-30
OUTPUT / AUSGÄNGE

PROJECT

FILENAME:17ELD1010 - 52756T05 - 20kw UK
DRAWING NO.

52756T05

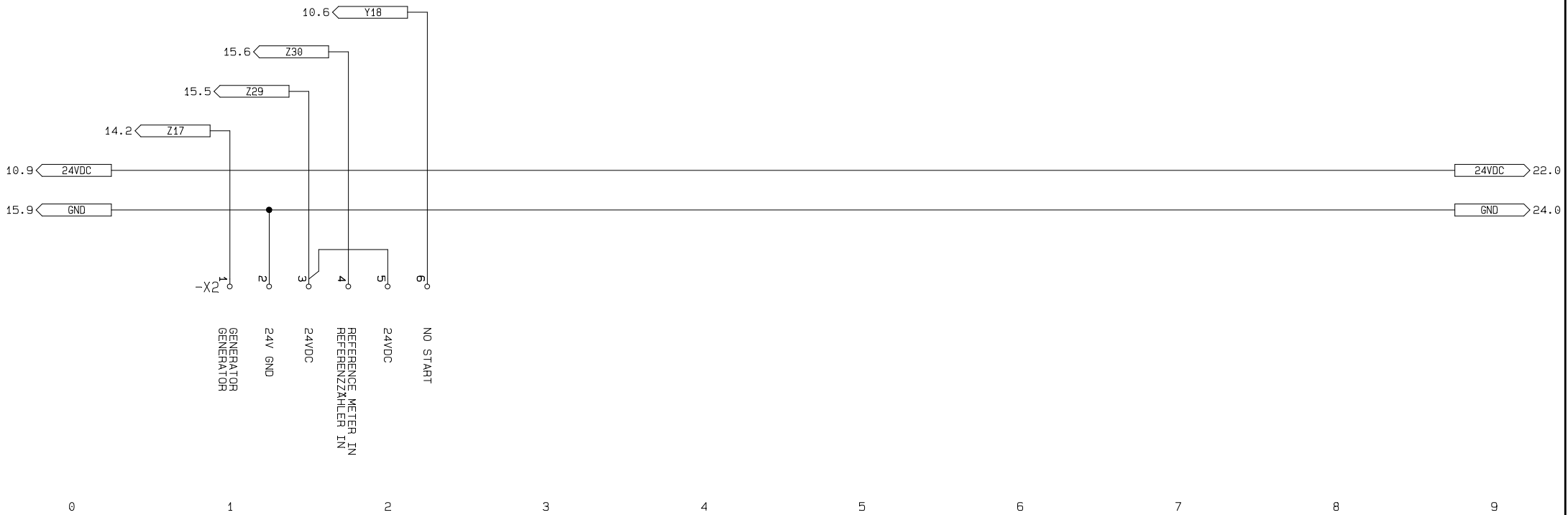

DRAW NO.
52756T05

THIS DRAWING MAY NOT BE COPIED OR DISCLOSED TO A THIRD PARTY WITHOUT OUR PERMISSION

EC POWER A/S
Samsøvej 25
DK - 8382 Hinnerup

Print date	21-10-2013
JHS	02-10-2013
OPR. JHS	17-12-2010

XRGI CONTROL PANEL / STEUERSCHRANK
TERMINAL ROW X2 /
KLEMMENREIHE X2

PROJECT

FILENAME:17ELD1010 - 52756T05 - 20kw UK
DRAWING NO.
52756T05
PAGE:17

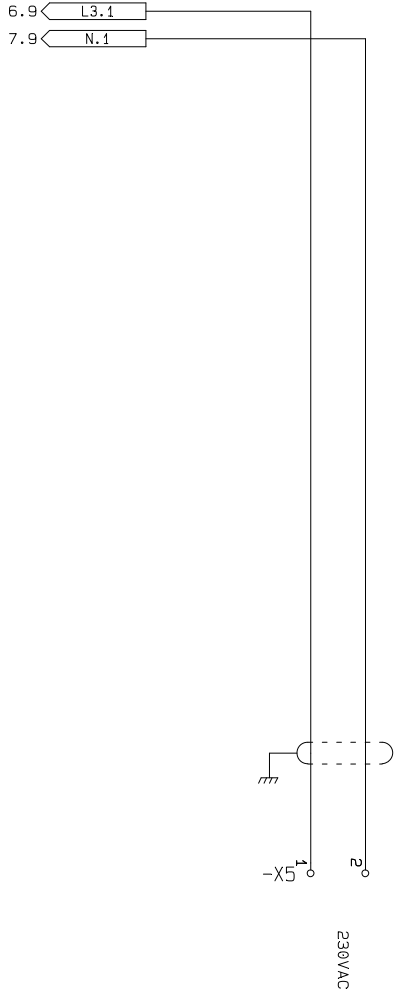

DRAW NO.
52756T05

THIS DRAWING MAY NOT BE COPIED OR DISCLOSED TO A THIRD PARTY WITHOUT OUR PERMISSION

EC POWER A/S
Samsøvej 25
DK - 8382 Hinnerup

Print date	21-10-2013
OPR.	JHS 17-12-2010

XRGI CONTROL PANEL / STEUERSCHRANK
TERMINAL ROW X5 /
KLEMMENREIHE X5

PROJECT

FILENAME:17ELD1010 - 52756T05 - 20kw UK
DRAWING NO.
52756T05
PAGE:20

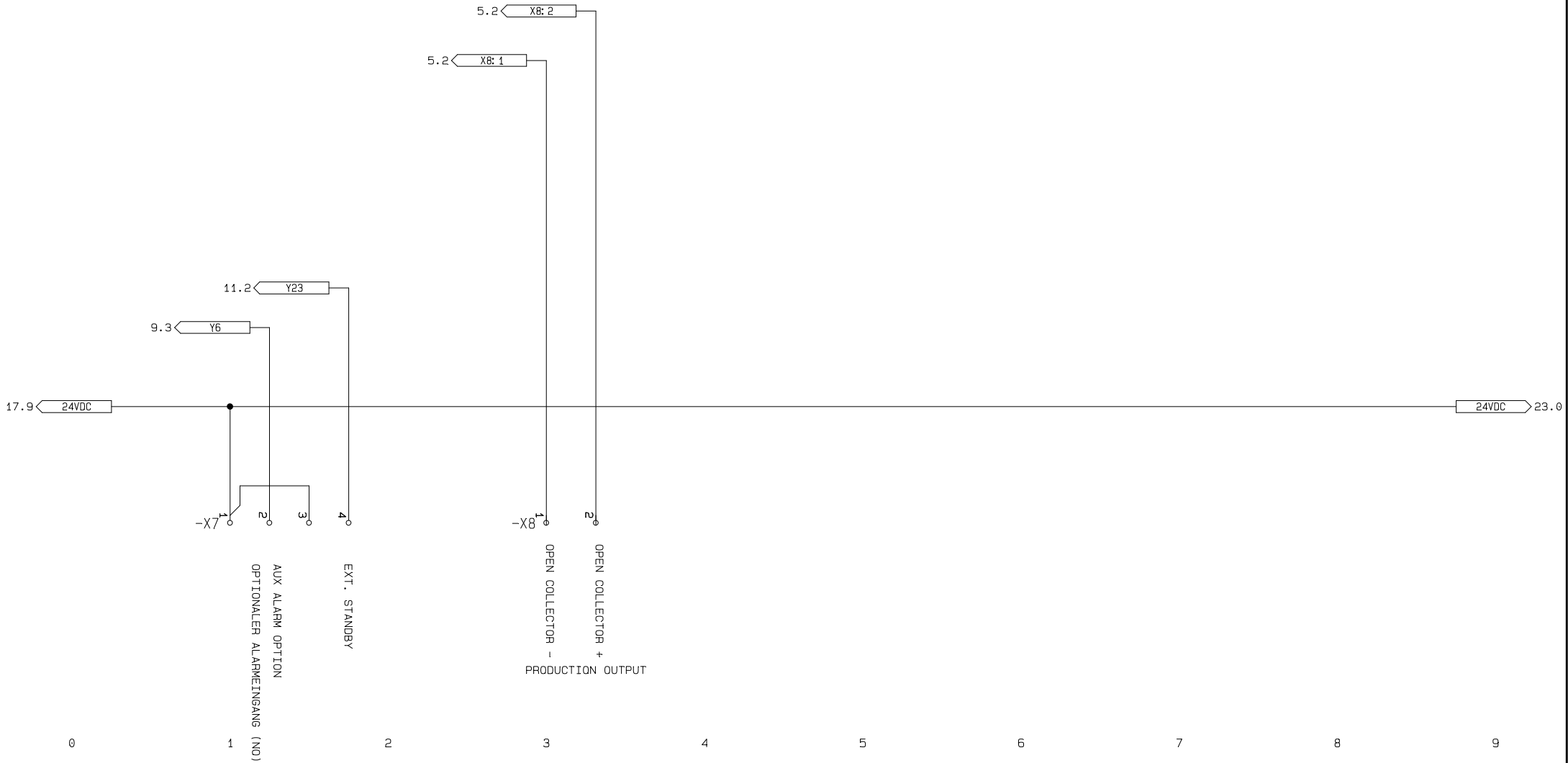

DRAW NO.
52756T05

THIS DRAWING MAY NOT BE COPIED OR DISCLOSED TO A THIRD PARTY WITHOUT OUR PERMISSION

EC POWER A/S
Samsøvej 25
DK - 8382 Hinnerup

Print date	21-10-2013
JHS	02-10-2013
OPR. JHS	17-12-2010

XRGI CONTROL PANEL / STEUERSCHRANK
TERMINAL ROW X7 / X8
KLEMMENREIHE X7 / X8

PROJECT

FILENAME:17ELD1010 - 52756T05 - 20k UK
DRAWING NO.
52756T05
PAGE:22

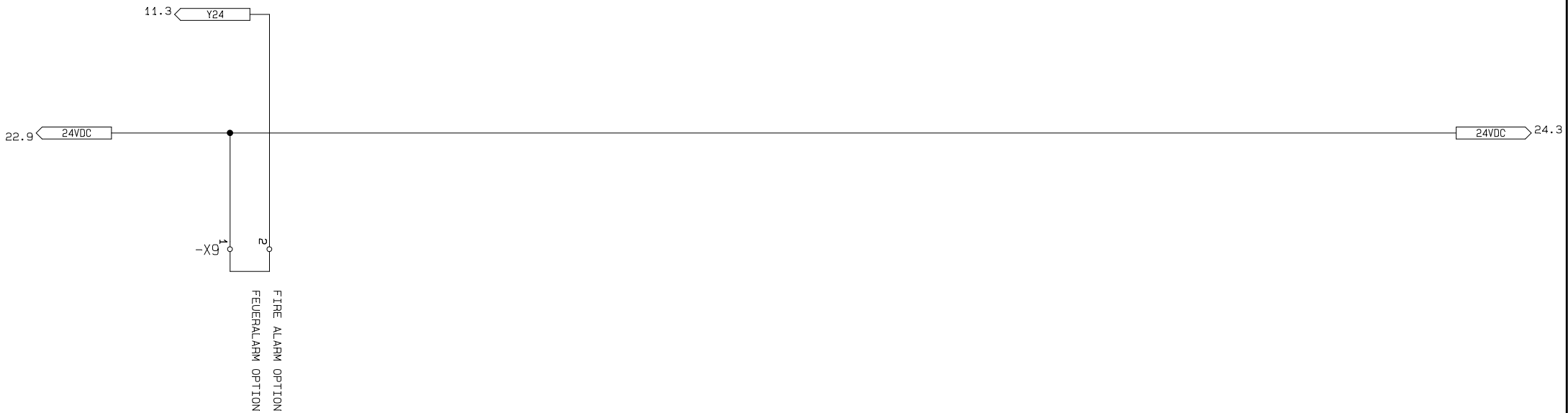

0 1 2 3 4 5 6 7 8 9

DRAW NO.
52756T05

THIS DRAWING MAY NOT BE COPIED OR DISCLOSED TO A THIRD PARTY WITHOUT OUR PERMISSION

EC POWER A/S
Samsøvej 25
DK - 8382 Hinnerup

Print date	21-10-2013
JHS	02-10-2013
OPR. JHS	17-12-2010

XRGI CONTROL PANEL / STEUERSCHRANK
TERMINAL ROW X9 /
KLEMMENREIHE X9

PROJECT

FILENAME:17ELD1010 - 52756T05 - 20kw UK
DRAWING NO.
52756T05
PAGE:23

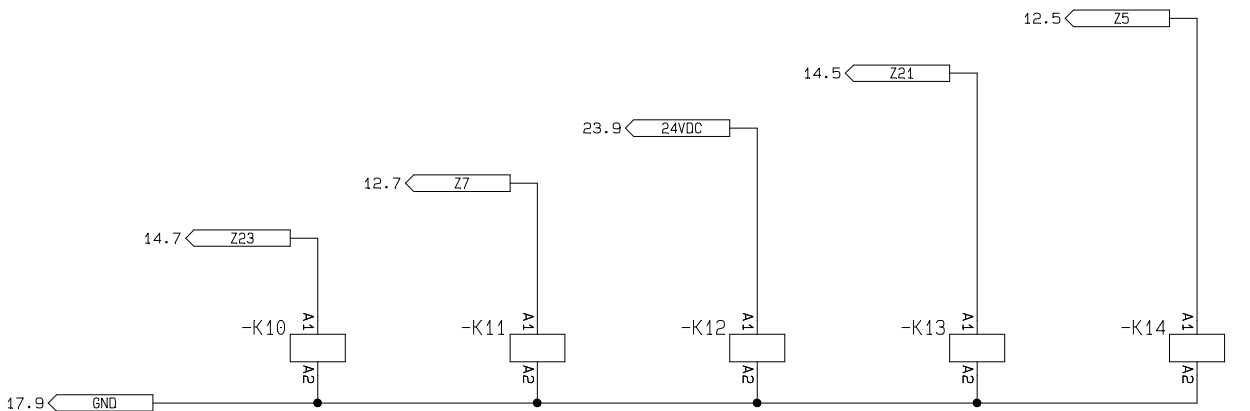

ALARM
STRÖMUNG



RUNNING
BETRIEB



POWER FACTOR
CORRECTION
BL INDSTROMSKOMPENSATION



HEAT PUMP 1
WÄRMEPUMPE 1



HEAT PUMP 2
WÄRMEPUMPE 2



0

1

2

3

4

5

6

7

8

9

THIS DRAWING MAY NOT BE COPIED OR DISCLOSED TO A THIRD PARTY WITHOUT OUR PERMISSION

EC POWER A/S
Samsøvej 25
DK - 8382 Hinnerup

Print date	21-10-2013
JHS	21-10-2013
OPR. JHS	17-12-2010

XRGI CONTROL PANEL / STEUERSCHRANK
ALARM CONNECTIONS /
ALARM AUSGÄNGE

PROJECT

FILENAME:17ELD1010 - 52756T05 - 20kw UK
DRAWING NO.

52756T05

PAGE:24

DRAW. NO.
52756T05

COMPONENT LIST / STÜCKLISTE

TAG NR.	PCS. ANZAHL	PART NO. ART. NR.	COMPONENT KOMPONENT	MANUFACTURER HERSTELLER
-A1	1	01ELF9131	PANEL 600X600X210 PANEL 600X600X210	EC POWER
-C1	1	SH GSX-V	CAPACITOR 1.5 uF CAPACITOR 1.5 uF	SUNON
-D1	1	01ELF5008	MOTHERBOARD IN-/OUTPUT MOTHERBOARD IN-/OUTPUT	EC POWER
-D2	1	01ELF9124	DISPLAY CARD DISPLAYKARTE	EC POWER
-D2.1	1	01ELF9096	FOAM GASKET F. DISPLAY SCHAUM PACKUNG FÜR DISPLAY	EC POWER
-D2.1	1	01ELT9027	PSC GLASS 130X76X1,5 + FILTER	EC POWER
-D2.1	1	01ELT9034	KEYBOARD iQ20 KEYBOARD iQ20	EC POWER
-D2.2	1	01ELF9100	RIBBON CABLE 34P (F)/90MM/34P(F) FLACHBANDKABEL 34P (F)/90MM/34P(F)	EC POWER
-D2.F1	1	01SPA3448	FUSE 250mA 5X20 SICHERUNG 250mA 5X20	EC POWER
-D2.F2	1	01SPA3078	FUSE 2, 0A 5X20 SICHERUNG 2, 0A 5X20	EC POWER
-D2.F3	1	01SPA3078	FUSE 2, 0A 5X20 SICHERUNG 2, 0A 5X20	EC POWER
-D3.1	1	01ELF9036	ANTENNA ¼ WAVE GSM DUALBAND/FME(F) ANTENNE ¼ WELLE GSM DUALBAND/FME(F)	EC POWER
-F1	1	01ELF9224	SURGE PROTECTION ÜBERSPANNUNGSSCHUTZ	DAN DELEKTRON
-F2	1	01ELF9201	RCCB 4P 40A 30MA	SCHNEIDER

DRAWING NO. 52756T05	THIS DRAWING MAY NOT BE COPIED OR DISCLOSED TO A THIRD PARTY WITHOUT OUR PERMISSION		Print date	21-10-2013	XRGi CONTROL PANEL / STEUERSCHRANK COMPONENTS LIST / STÜCKLISTE	PROJECT	FILENAME:17ELD1010 - 52756T05 - 20kw UK
	EC POWER A/S Samsøvej 25 DK - 8382 Hinnerup						DRAWING NO.
			JHS	21-10-2013			52756T05
			OPR. JHS	17-12-2010			

COMPONENT LIST / STÜCKLISTE

TAG NR.	PCS. ANZAHL	PART NO. ART. NR.	COMPONENT KOMPONENT	MANUFACTURER HERSTELLER
-F2	1	01ELF9201	RCCB 4P 63A 30MA	SCHNEIDER
-F4	1	01ELF9140	C60N 4P 6A 6kA	SCHNEIDER
-F5	1	01ELF9203	AUTOMATICFUSE 1A 1P+N COMPACT	SCHNEIDER
-G1	1	01ELF9151	METAL CASE FOR PSU - EC POWER	AE PARTNER
-G1	1	01ELF9191	POWER SUPPLY 230VAC/ 24VDC STROMVERSORGUNG 230VAC/ 24VDC	EC POWER
-K1	1	01ELF9136	LOSS OF MAINS PROTECTION RELAY - THREE PHASE 4-WIRE SYSTEM LOSS OF MAINS PROTECTION RELAY - THREE PHASE 4-WIRE SYSTEM	MEGACON
-K5	1	01ELF9135	CONTACTOR 43A 230V50/60HZ CONTACTOR 43A 230V50/60HZ	ALLEN-BRADLEY
-K5	1	01ELF9107	AUX.BLOCK FRONT MOUNTED 2 NO, 2 NC HILFSCHALTERBLOCK 2 NO, 2 NC	ALLEN-BRADLEY
-K5	1	01ELF9137	AUX.BLOCK SIDE MOUNTED 1 NO, 1NC HILFSCHALTERBLOCK SEITLICH 1 NO, 1NC	ALLEN-BRADLEY
-K5.1	1	01ELF9153	PLC-INTERFACE RELAY PLC-INTERFACE RELAY	PHOENIX CONTACT
-K5.1	1	01ELF9105	RELAY SNR 6, 3MM 1CO 24VDC RELAY SNR 6, 3MM 1CO 24VDC	SCHRACK
-K7	1	01ELF9153	PLC-INTERFACE RELAY PLC-INTERFACE RELAY	PHOENIX CONTACT
-K10	1	01ELF9153	PLC-INTERFACE RELAY PLC-INTERFACE RELAY	PHOENIX CONTACT
-K11	1	01ELF9153	PLC-INTERFACE RELAY PLC-INTERFACE RELAY	PHOENIX CONTACT

DRAWING NO. 52756T05	THIS DRAWING MAY NOT BE COPIED OR DISCLOSED TO A THIRD PARTY WITHOUT OUR PERMISSION		Print date	21-10-2013	XRGi CONTROL PANEL / STEUERSCHRANK COMPONENTS LIST / STÜCKLISTE	PROJECT	FILENAME:17ELD1010 - 52756T05 - 20kw UK
	EC POWER A/S Samsøvej 25 DK - 8382 Hinnerup						DRAWING NO.
			JHS	02-10-2013			52756T05
			OPR. JHS	17-12-2010			

COMPONENT LIST / STÜCKLISTE

TAG NR.	PCS. ANZAHL	PART NO. ART. NR.	COMPONENT KOMPONENT	MANUFACTURER HERSTELLER
-K12	1	01ELF9153	PLC-INTERFACE RELAY PLC-INTERFACE RELAY	PHOENIX CONTACT
-K13	1	01ELF9153	PLC-INTERFACE RELAY PLC-INTERFACE RELAY	PHOENIX CONTACT
-K14	1	01ELF9153	PLC-INTERFACE RELAY PLC-INTERFACE RELAY	PHOENIX CONTACT
-M5	2	01ELF9210	92X92 FINGER GUARD	SUNON
-M5	1	01ELF9211	FAN AC 92x92x25MM 230VAC	SUNON
-M5	1	01ELF9209	FAN HOLDER ADAPTER	AEP
-P1	1	01ELF9126	3 PHASE ENERGY ANALYZER 3 PHASIG ZÄHLER	CARLO GAVAZZI
-Q1	1	01ELF9130	HANDLE RED-YELLOW ON-OFF IP65 DREHGRIF F ROT-GELB ON-OFF IP65	ABB
-Q1	1	01ELF9129	MAIN SWITCH DISCONNECTOR 63A 4P HAUPTSCHALTER VORSATZ SCHWARZ 63A 4P	ABB
-U1	1	01ELF9138	SOFTSTARTER SMC-3 150 C43nBR SOFTSTARTER SMC-3 150 C43nBR	ALLEN BRADLEY
-W1	1	01ELF9132	BUSBAR 4P MAX 100A 3XMCCB BUSBAR 4P MAX 100A 3XMCCB	SCHNEIDER
-X0	2	01ELF9183	END CLAMP, WIDTH 9,5MM END CLAMP, WIDTH 9,5MM	PHOENIX CONTACT
-X0	7	01ELF9181	TERMINAL 1,5MM ² -25MM ² TERMINAL 1,5MM ² -25MM ²	PHOENIX CONTACT
-X0	1	01ELF9182	END COVER, WIDTH 2,2MM END COVER, WIDTH 2,2MM	PHOENIX CONTACT

DRAWING NO. 52756T05	THIS DRAWING MAY NOT BE COPIED OR DISCLOSED TO A THIRD PARTY WITHOUT OUR PERMISSION		Print date	21-10-2013	XRG I CONTROL PANEL / STEUERSCHRANK COMPONENTS LIST / STÜCKLISTE	PROJECT	FILENAME:17ELD1010 - 52756T05 - 20kw UK
	EC POWER A/S Samsøvej 25 DK - 8382 Hinnerup						DRAWING NO.
			JHS	02-10-2013			52756T05
			OPR. JHS	17-12-2010			

COMPONENT LIST / STÜCKLISTE

TAG NR.	PCS. ANZAHL	PART NO. ART. NR.	COMPONENT KOMPONENT	MANUFACTURER HERSTELLER
-X2	1	01ELF9183	END CLAMP, WIDTH 9,5MM END CLAMP, WIDTH 9,5MM	PHOENIX CONTACT
-X2	6	01ELF9185	TERMINAL 2,5MM ² TERMINAL 2,5MM ²	PHOENIX CONTACT
-X2	1	01ELF9186	END COVER 2,2MM END COVER 2,2MM	PHOENIX CONTACT
-X5	1	01ELF9183	END CLAMP, WIDTH 9,5MM END CLAMP, WIDTH 9,5MM	PHOENIX CONTACT
-X5	2	01ELF9185	TERMINAL 2,5MM ² TERMINAL 2,5MM ²	PHOENIX CONTACT
-X5	1	01ELF9186	END COVER 2,2MM END COVER 2,2MM	PHOENIX CONTACT
-X7	1	01ELF9183	END CLAMP, WIDTH 9,5MM END CLAMP, WIDTH 9,5MM	PHOENIX CONTACT
-X7	4	01ELF9185	TERMINAL 2,5MM ² TERMINAL 2,5MM ²	PHOENIX CONTACT
-X7	1	01ELF9186	END COVER 2,2MM END COVER 2,2MM	PHOENIX CONTACT
-X8	1	01ELF9185	TERMINAL 2,5MM ² TERMINAL 2,5MM ²	PHOENIX CONTACT
-X9	1	01ELF9183	END CLAMP, WIDTH 9,5MM END CLAMP, WIDTH 9,5MM	PHOENIX CONTACT
-X9	2	01ELF9185	TERMINAL 2,5MM ² TERMINAL 2,5MM ²	PHOENIX CONTACT
-X9	1	01ELF9186	END COVER 2,2MM END COVER 2,2MM	PHOENIX CONTACT
-X100	2	01ELF9134	RJ45 PATCH CABEL S/FTP 1MTR. RJ45 PATCH CABEL S/FTP 1MTR.	EC POWER

DRAWING NO. 52756T05	THIS DRAWING MAY NOT BE COPIED OR DISCLOSED TO A THIRD PARTY WITHOUT OUR PERMISSION		Print date	21-10-2013	XRGi CONTROL PANEL / STEUERSCHRANK COMPONENTS LIST / STÜCKLISTE	PROJECT	FILENAME:17ELD1010 - 52756T05 - 20kw UK	52756T05	DRAWING NO.	PAGE:28
	EC POWER A/S Samsøvej 25 DK - 8382 Hinnerup									
			JHS	02-10-2013						
			OPR. JHS	17-12-2010						

