

Always read before installation.

# **AISIN GHP** Aisin Gas Heat Pump Air Conditioner

## **GHP OUTDOOR UNIT INSTALLATION INSTRUCTIONS**

### **E1 Multi Zone Type**

#### **Standard – Renewal**

#### **[Model P224 - P280 - P355]**

#### ■ Applicable models

Outdoor unit		Specification						
		Mod.	Natural gas	LPG	G25	CAT	AWS	W-KIT
Multi zone type Standard specification	<b>P224</b>	AXGP224 E1	N(F)WE	P(F)WE	G(F)WE	D	A	K
	<b>P280</b>	AXGP280 E1	N(F)WE	P(F)WE	G(F)WE	D	A	K
	<b>P355</b>	AXGP355 E1	N(F)WE	P(F)WE	G(F)WE	D	A	K
Multi zone type Renewal specification	<b>P224</b>	AXYGP224 E1	N(F)WE	P(F)WE	G(F)WE	D	A	K
	<b>P280</b>	AXYGP280 E1	N(F)WE	P(F)WE	G(F)WE	D	A	K
	<b>P355</b>	AXYGP355 E1	N(F)WE	P(F)WE	G(F)WE	D	A	K

(F) Indicates the cold district model specification

#### ■ A word to the person in charge of installation

This GHP OUTDOOR UNIT INSTALLATION INSTRUCTIONS provides the installation procedures and precautions for those with a basic knowledge of gas heat pumps. Improper installation will not realize the unit's full performance potential and could even cause injury or damage to the unit.

Accordingly, read and fully understand the contents of this manual before beginning the installation of the GHP outdoor unit, and install the GHP properly according to the content of this manual. If indoor units, a remote controller or other options, sold separately, are also to be installed, read and fully understand the contents of those units' manuals as well.

#### Important reminder

- Be sure to check the model code of the GHP outdoor unit before installation. (The model code is written on the plate at the bottom-right position in the rear of the GHP.)
- This unit must be installed by specially trained personnel.
- The installation must be surely performed in accordance with the contents of this manual.
- Perform test operation within 3 months since installation of the GHP on the base.



After installation, always call the local AISIN Authorised Service centre to perform commissioning.

## ■ Safety Precautions



---

In this manual, the precautions to prevent injuries and damages that can occur if this unit is improperly installed are divided into and covered under the “⚠ Warning” and “⚠ Caution” graphics. In addition, “symbols” are used to indicate proper instructions. Follow these instructions carefully.

### What “⚠ Warning” and “⚠ Caution” mean

 <b>Warning</b>	If the items with this symbol shown in this manual are not adhered to, serious injury or death could occur.
 <b>Caution</b>	If the items with this symbol shown in this manual are not adhered to, injury or damage to the unit could occur.

### What “symbols” mean

	This indicates prohibited action.
	This indicates an action or requirement that must be completed.



**TECNOCASA**  
CLIMATIZZAZIONE

Sole European Distributor **AISIN**  
Gas Heat Pump (GHP) / Microcogenerator (MCHP)

# TABLE OF CONTENTS

## Main Unit and Piping

1. Before Installing.....4	4-2. Check existing piping specifications ..... 14
1-1. Notes for renewal specification (reusing existing piping)..... 4	4-3. Refrigerant piping installation specifications..... 15
1-2. Combinations and capacities of the outdoor units and indoor units ..... 5	4-4. Refrigerant piping - Selecting branch pipes and permissible lengths..... 15
1-3. Parts provided ..... 6	4-5. Precautions during the installation of refrigerant piping ..... 20
1-4. Locally procured parts ..... 6	4-6. Notes for branch piping ..... 24
2. Transporting Outdoor Unit .....7	4-7. Stop valve connections and opening / closing ..... 25
2-1. Check the transporting route ..... 7	4-8. Refrigerant vapor leakage test and vacuuming ..... 26
2-2. Methods for transporting the outdoor unit..... 7	4-9. Refrigerant charging..... 28
2-3. Dimensions related to transporting the outdoor unit..... 7	4-10.Refrigerant piping insulation and heat retention ..... 29
3. Installation .....9	4-11.How to secure refrigerant piping ..... 29
3-1. Select the location for installation ..... 9	5. Fuel Gas Piping Installation ..... 30
3-2. Space required for installation .....11	6. Drain Piping Installation ..... 31
3-3. Foundation and anchor bolt specifications ... 12	7. How to Extend Exhaust Pipe ..... 34
4. Refrigerant Piping.....14	
4-1. Outline diagram of refrigerant piping ..... 14	

## Electrical

8. Summary of Electric Wiring Installation .....36	9-2. Signal wire between indoor-outdoor units and outdoor-outdoor units ..... 39
8-1. Opening for power supply wires / signal wires..... 36	9-3. Remote control wire ..... 40
8-2. Wiring example..... 37	10. Power Supply Wiring Procedure ..... 41
9. Electric Wire Specifications and Precautions .....38	10-1.Wiring instruction..... 41
9-1. Power supply wire ..... 38	10-2.Wiring length ..... 42
	10-3.Branch wiring ..... 43

## After Installation

11. Various Function Settings.....44	12. Remote Control..... 51
11-1.Address setting method of the indoor and outdoor units ..... 44	12-1.Remote control with 2 remote controllers..... 51
11-2.EEP dip switch setting..... 44	12-2.Group control ..... 51
11-3.Gas type setting ..... 47	13. Test Operation..... 52
11-4.Field settings with the remote controller..... 48	13-1.Before starting test operation ..... 52
11-5.List of setting contents and mode numbers.....49	13-2.Process of the outdoor unit when turning on the power..... 52
	13-3.When installing additional indoor / outdoor units or replacing the indoor / outdoor unit PCB ..... 56

## Reference

14. Installation Check List .....58	2. Cancelling the error codes ..... 61
(Reference) Troubleshooting .....59	(Reference) GHP Specifications.....62
1. Error code display..... 59	

---

# 1. Before Installing

---

## 1-1. Notes for renewal specification (reusing existing piping)

When performing renewal installation (reusing existing piping), read this manual and "Gas heat pump air conditioner renewal manual" carefully, and install the unit properly according to the contents of the manuals. Improper installation will not realize the unit's full performance potential and could even cause damage to the unit.

### ■ Items to be checked for renewal installation

#### 1) Installing outdoor units

- Be sure to use M 12 anchor bolts if the anchor bolts are smaller than M12. If the location of the anchor bolts is different from the bolt location of this unit, location change is necessary. (Refer to "3-3. Foundation and anchor bolt specifications" on page 12.)
- When performing renewal installation from EHP, check the strength and size of the foundation. Foundation change is necessary if the strength is insufficient.
- When performing renewal installation from EHP, install an antivibration mount if a vibration problem is likely to occur. (Refer to "3-3. 3) Antivibration mount" on page 13.)

#### 2) Installing indoor units

- Because the location of the suspension bolts for the indoor units are changed, install the indoor units according to the new indoor unit specification.

#### 3) Fuel gas piping

- Replace the reinforced gas hose of the existing outdoor unit with the new hose. (Gas hose change is required if the gas piping connecting location or connection size is different between the existing outdoor unit and new outdoor unit.) (Refer to "5. Fuel Gas Piping Installation" on page 30.)
- When performing renewal installation from EHP, new installation of the fuel gas piping is required.

#### 4) Refrigerant piping and refrigerant oil

- Design pressure of the pipes and branch pipes must be 3.3 MPa or higher. Check that the pipes have no corrosion.
- The height difference between the indoor and outdoor units, and between indoor units must be within specification range of the new outdoor unit (AISIN GHP). (Refer to "4. Refrigerant Piping" on page 14.)
- Once the existing outdoor units or indoor units are removed, block the refrigerant pipes with a tape as soon as possible to prevent water or dust from entering the piping.
- If the pipe size is different between existing piping and renewal unit piping (including indoor unit piping), connect the pipes by changing the size with the reducer or other means.
- Look into the trouble history of the existing units. Check if there were any troubles such as compressor failure or refrigerant shortage possibly due to piping failure. If there are such trouble histories, check if the troubled part was repaired. If the troubled part was not repaired, repair the part.
- Clean up the piping if there is a history of compressor failure.
- If the thermal insulation or lagging of the existing piping is deteriorated, repair the insulation or attach the new insulation.
- Pay attention to the refrigerant oil. Piping cleaning is necessary depending on the refrigerant oil type. (Refer to "Gas heat pump air conditioner renewal manual".)
- The piping without insulation on the liquid pipe can not be used.
- The flare nuts connected to the existing indoor units must be replaced with the flare nuts attached to the new indoor units.



- The foreign objects left in the piping can cause expansion valve malfunction or strainer clogging. If the existing outdoor units are operable, operate cooling for 10-15 minutes, and then perform pump down operation before removal. After that, remove the existing outdoor units.

#### 5) Drain piping

- If the drain piping of the existing indoor units has clogging or insulator deterioration, replace the drain piping with the new one. (Refer to “6. Drain Piping Installation” on page 31.)  
(If the drain pipe connecting location or size is different between the existing and new indoor units, drain piping change is required.)
- If the drain piping of the existing outdoor units has clogging or material (PVC: polyvinyl chloride) deterioration, replace the drain piping with the new one.  
(If the drain pipe connecting location or size is different between the existing and new outdoor units, drain piping change is required.)

#### 6) Electric wiring

- Check the specification of the power supply wiring (signal wiring between indoor and outdoor units, and remote control wiring) according to “9. Electric Wire Specifications and Precautions” on page 38 of this manual. If the wiring does not meet the standard or is damaged in appearance, replace the wiring with the new one.
- Refer to “[Gas heat pump air conditioner renewal manual](#)” as for how to reuse the power supply wiring, signal wiring between indoor and outdoor units, and remote control wiring.

## 1-2. Combinations and capacities of the outdoor units and indoor units

### Important reminder

- **Install the indoor units that correspond to indoor air conditioning load. Otherwise, the units frequently repeat start and stop. That could result in breakdown of the units.**
- **The number and total capacity of the connected indoor units must be within the range shown below. Connecting indoor units out of this range could result in breakdown.**

Outdoor unit	Number of connectable indoor units	Total capacity of connectable indoor units (kW)
P224	1 to 20 (13)	11.2 to 44.8 (29.1)
P280	1 to 25 (16)	14.0 to 56.0 (36.4)
P355	1 to 32 (20)	17.8 to 71.0 (46.2)



( ) shows the maximum value for cold district specification.

- In a combination in which the total capacity of the connected indoor units exceeds the capacity of the outdoor unit, the performance of each indoor unit will be lower than its rated capacity when all indoor units are operated simultaneously. Always strive to keep the total capacity of the indoor units within the outdoor unit capacity.
- Permissible piping length is restricted up to 100 m (actual length), and total piping length is restricted up to 350 m when the total capacity of the connected outdoor unit exceeds 130 % of rated capacity.
- P224 outdoor unit: Connectable indoor units are P22 to P224.
- P280 outdoor unit: Connectable indoor units are P22 to P280.
- P355 outdoor unit: Connectable indoor units are P22 to P280.

### 1-3. Parts provided

The following parts are provided with this outdoor unit. Check the contents.

	Name
	This manual (INSTALLATION INSTRUCTIONS)
Shape	
Quantity	1

	Name	
	Reducer (vapor line)	Reducer (liquid line)
Shape		
Quantity	4 types (1 piece each) (Inner diameter: 19.1 / Outer diameter: 25.4) (Inner diameter: 22.2 / Outer diameter: 25.4) (Inner diameter: 28.6 / Outer diameter: 25.4) (Inner diameter: 31.8/ Outer diameter: 25.4)	2 types (1 piece each) (Inner diameter: 9.5 / Outer diameter: 12.7) (Inner diameter: 15.9/ Outer diameter: 12.7)
Location provided	Inside of refrigerant compartment	
Notes	Select the proper reducer according to the refrigerant pipe diameter. Refer to "4-2. Check existing piping specifications" on page 14.	

### 1-4. Locally procured parts

The following items are required for installing this GHP.

● Parts required

Part	Application
Anchor bolt	For installing outdoor unit (M12 × 4 pcs)
Washer, nut	For installing outdoor unit (M12 × 4 pcs)
Suspension bolt (M10), nut	For installing indoor units (4 pcs per indoor unit)
Copper pipe (C1220T)	For refrigerant piping (Refer to "4-4. Refrigerant piping - Selecting branch piping and permissible lengths" on page 16)
Hard plastic (PVC: polyvinyl chloride) pipe (VP)	For outdoor unit drain (VP20, VP30, VP50)
Steel pipe (SGP)	For fuel gas piping (3/4 B)
Reinforced gas hose	For fuel gas piping
Insulating material	For refrigerant and drain pipe insulation
Power supply wire	For electric power supply for indoor and outdoor units (Refer to "9-1. Power supply wire" on page 38)
Signal wire between indoor and outdoor units	For communication between indoor and outdoor units (Refer to "9-2. Signal wire between indoor-outdoor units and outdoor-outdoor units" on page 39)
Remote control wire	For connecting indoor unit and remote controller (Refer to "9-3. Remote control wire" on page 40)
Ground wire	For grounding the outdoor unit
Refrigerant	For additional charging (R410A)
Refrigerant oil	For applying to the flares (NL10)
Crimp pipe	For header branch pipes

(Note) Specifications of above listed parts must comply with the relevant local and national regulations and technical standards.



## 2. Transporting Outdoor Unit

### 2-1. Check the transporting route

- Make sure that the route to the installation site and any openings are large enough for the outdoor unit to be transported through.
- Make sure that the route to the installation site has the strength to withstand the weight of the outdoor unit.

### 2-2. Methods for transporting the outdoor unit

- Use nylon slings rigged in the manner shown in the illustration below. Protect the outdoor unit wherever necessary to prevent damage or deformity. Take care so that the refrigerant piping or exhaust water drain hoses are not pinched.

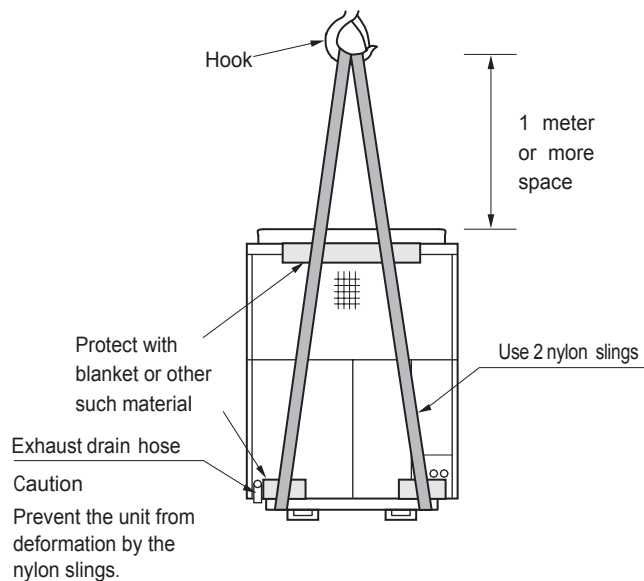

- If a forklift is used for transport, spread the fork as wide as possible so that they fit in the opening at the bottom of the unit (as shown in the illustration below). Insert the forks completely, taking care not to damage the unit with the forks.

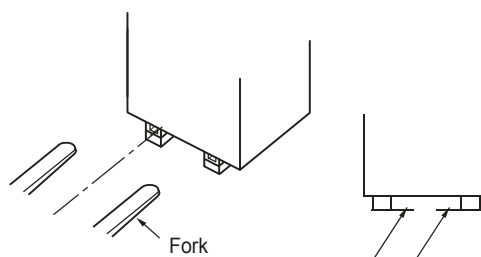

- Do not tilt the unit 30° or more. (Never tip the unit on its side)

### 2-3. Dimensions related to transporting the outdoor unit (when the wooden blocks under the legs of the outdoor unit are removed)

Outdoor unit	Transport dimensions (mm)	Mass (kg)
P224	1416(W) □ 986(D) □ 2077(H)	565 standard
P280		
P355		570 renewal

\* The cold district specification increases the mass by 5 kg. The catalyser option also increases the mass by 5 kg.

## ■Preparation and precautions for transporting with an elevator

### 【Important reminders】

- The outdoor unit must be transported by experts for heavy weight transportation.
- Carefully consider transporting route, transporting method, and installing method on the foundation of the outdoor unit before starting transportation.
- Be sure to check that the elevator can carry the outdoor unit.
  - \* Some elevators can not carry the outdoor unit even if the elevators meet the standard shown below.  
When you use an elevator for transporting the outdoor unit, be sure to consult the manufacturer of the elevator and follow the manufacturer's precautions.
- Check the dimensions of the elevator (width, depth and height). (Take into account the size of the tools for transportation.)
- Check the maximum loading capacity of the elevator. (Take into account the mass of the tools for transportation.)
  - \* Refer to "2-3. Dimensions related to transporting the outdoor unit" on the previous page for the dimensions and mass of the outdoor unit.

### <Recommendation>

- Effective entrance dimensions (elevator door)  
Width: 1,000 mm or more  
Height: 2,100 mm or more
- Inner dimensions of the car (inside the elevator)  
Width: 1,800 mm or more  
Depth: 1,500 mm or more  
Height: 2,300 mm or more
- Maximum loading capacity  
1,150 kg or more
- Protect the carry-in and carry-out path and inside of the elevator with wooden boards or other materials.
  - Take care so that the floor, wall and doors of the building, and inside of the elevator are not damaged.
  - On the floor, place boards that can withstand the load of outdoor unit transportation.
- If the outdoor unit fixing brackets or fan guards on the roof hinder carrying the outdoor unit into the elevator, you can remove them temporarily.  
<How to remove the outdoor unit fixing brackets>
  1. Remove the outside panel (front and rear) of the outdoor unit.
  2. Loosen the bolts with a box-end wrench and remove the fixing brackets. (Refer to figure A)
  3. Be sure to attach the fixing brackets at their original locations after completion of transportation. (Bolt tightening torque:  $37 \pm 11 \text{ N} \cdot \text{m}$ )
  - \* Failing to tighten the bolts with the specified torque could cause outdoor unit fixing failure.
  - \* Be sure to attach the removed outside panels as before. (Screw tightening torque:  $6.0 \pm 1.8 \text{ N} \cdot \text{m}$ )

### <How to remove the fan guards>

1. Prepare a stepladder or other tools for high-place work. Loosen the fan guard fixing screws on the roof of the outdoor unit with a Phillips-head screwdriver, and remove the fan guards. (Refer to figure B)
  - \* Do not lose the fixing screws.
  - \* Do not apply excessive force on the fan guards. That could deform the fan guards.
  - \* Take extra care when working because you work in a high place.
2. Be sure to attach the fan guards at their original locations after completion of transportation. (Bolt tightening torque:  $4.1 \pm 1.2 \text{ N} \cdot \text{m}$ )
  - \* Failing to tighten the screws with the specified torque could cause the fan guards to come off.

<FIGURE A>

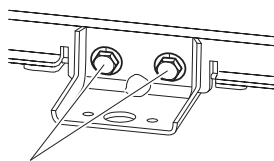

Use a box-wrench.  
(tighten with the specified force)

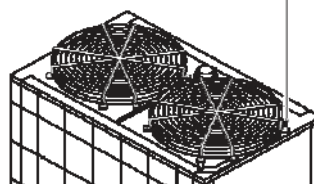

<FIGURE B> Use a Phillips-head screwdriver (all round the fan guards).  
(Tighten with the specified torque.)







## 3. Installation

### 3-1. Select the location for installation

 <b>Warning</b>	
	<ul style="list-style-type: none"> <li>■ <b>Never install the outdoor unit at a indoor location.</b></li> <li>■ <b>Never install the outdoor unit at a location where the exhaust gas could flow into the room.</b> If the outdoor unit is installed near the intake/exhaust port to the room, window or ventilation port, the exhaust gas could flow into the room and cause gas poisoning or an accident due to lack of oxygen.</li> <li>■ <b>Never install the outdoor unit in an area where flammable gas can be produced, flow into, accumulate or leak, or where volatile flammable materials can be treated.</b> Installation at such locations could result in a fire or an explosion.</li> </ul>
	<ul style="list-style-type: none"> <li>■ <b>Always install the outdoor unit at an outdoor area open to the atmosphere.</b> If the exhaust gas accumulates, it could cause gas poisoning or an accident due to lack of oxygen. Install the outdoor unit where adequate ventilation is provided.</li> <li>■ <b>Make sure that the area where the outdoor unit is going to be installed is strong enough to withstand the unit's mass.</b> If the location is not strong enough, the outdoor unit could fall over and cause injury or accident.</li> <li>■ <b>Always discharge the exhaust gas to the atmosphere at a location where the gas will not cause adverse affects on the surrounding area.</b> If the exhaust gas is exhausted into the catch basin or ditch, it could be drawn into the room and cause gas poisoning or an accident due to lack of oxygen.</li> </ul>

 <b>Caution</b>	
	<ul style="list-style-type: none"> <li>■ <b>Never install the outdoor unit at a location where its exhaust gas or air from its blower fan will come in contact with plants or animals.</b> The exhaust gas or discharged air could cause harm to these plants or animals.</li> <li>■ <b>When the outdoor unit is installed on the roof or at a high location, install a permanent ladder or railings along the path to the unit, and install a fence or railings around the unit for the worker.</b> If these devices are not installed, the worker could fall.</li> </ul>

\* If there is no choice of installation location other than where the exhaust gas could flow into the room or could cause harm to the surroundings, extend the exhaust pipe. refer to "7. How to Extend Exhaust Pipe" on page 34 for details.

---

### Important reminder

- Always install the outdoor unit at a location where its operating noise and vibration will not cause problems for those below or surrounding the unit. (This is especially important when installing in residential areas.)
- Install the outdoor unit where the discharged air from the fan does not blow on nearby homes.
- Install the outdoor unit at a level location where rainwater does not penetrate and water does not accumulate.
- Install the outdoor unit at a location where it will not be exposed to strong winds.
- The noise from the outdoor unit may cause adverse effect on other electrical equipment. Always install the unit at a location distant enough from the electrical equipments such as televisions, radios, computers, telephones and their antennas, electrical wires, and signal wires.
- Install the outdoor unit at a location where heat from other equipment does not cause adverse effect on the unit.
- If the outdoor unit is installed in a heavy snowfall area, install the unit where accumulated snow does not fall on the unit, and install the optional snow hood as well. Also make sure that the foundation for the unit is high enough so as not to be affected by accumulated snow.
- Allocate the route for loading/unloading the equipment, materials and parts for maintenance at the installation site (minimum route width: 900 mm, maximum mass of equipment, materials and parts: 150 kg).



### 3-2. Space required for installation

#### 1) Provide sufficient distance from flammable materials

<b>Warning</b>	
	<p>■ <b>Install the outdoor unit in the proper distance from flammable items as required by the relevant local and national regulations, and technical standards. (See the reference below.)</b> If the distance does not meet the requirements, it could result in a fire.</p>

Reference: Fire-prevention certified gas-operated equipment (Japanese regulation)	
Distance from flammable materials (mm)	

The front of the outdoor unit is the side where the following name plate is attached.

#### 2) Installation space

<b>Caution</b>	
	<p>■ <b>The following drawings show the minimum installation space for providing room for intake air and inspection and maintenance operations.</b> Insufficient space could result in injury to the maintenance personnel or damage to the equipment.</p>

Provide ample space for inspection and maintenance taking into account the refrigerant and fuel gas piping.

<p>Front view</p> <p>2 m or more</p> <p style="text-align: center;">Foundation</p> <p>Provide space of 2 m or more above the unit.</p>	<p>Top view</p> <div style="display: flex; justify-content: space-around;"> <div style="text-align: center;"> <p>&lt;Single unit installation&gt;</p> <p>500 mm or more</p> <p>700 mm or more</p> <p>Either A or B must be 100 mm or more. The other side must be 350 mm or more.</p> </div> <div style="text-align: center;"> <p>&lt;Multiple unit installation&gt;</p> <p>500 mm or more</p> <p>700 mm or more*1</p> <p>*1 When you consider reducing this space, contact our sales office. This space must be 800 mm or more when the snow hood is mounted.</p> <p>*2 When 4 or more units are installed in a row, provide a service space for every 3 units.</p> </div> </div>
--	--

#### Important reminder

- **When 4 or more of outdoor units are installed in the same location, nearby walls or other objects could obstruct air flow and cause short circuit. To prevent a decline in performance and trouble due to short circuit of airflow, larger installation space is necessary. Contact an authorized dealer for details.**

### 3-3. Foundation and anchor bolt specifications

#### 1) Foundation shape

**Warning**

■ **The foundation must provide a firm and level surface for installing the outdoor unit so that the outdoor unit does not tip over in the event of strong winds (typhoons, etc.) or earthquake.** If the foundation strength is insufficient, the outdoor unit could tip over and cause fuel gas leakage or injury.

- The foundation must have sufficient strength in accordance with the drawings below. In order to protect the outdoor unit from rain, dust and damage, the height of the foundation must be 200 mm from the ground. The foundation must have grooves around itself that directs drain water to the drainage port.
- The foundation must support the mass of the outdoor unit evenly and must be flat and smooth so that water will not accumulate on the upper surface.
- Never use a foundation that consists of more than one piece of block. Such a foundation will not provide necessary strength.
- Condensation water may drip from the bottom of the outdoor unit. Install a drain pan if the condensation water could cause problems.

<Above-ground installation>

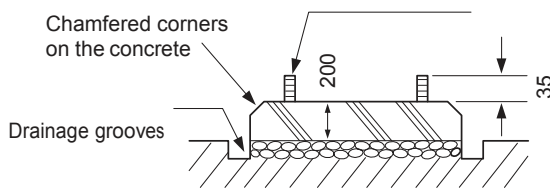

<Roof-top installation>

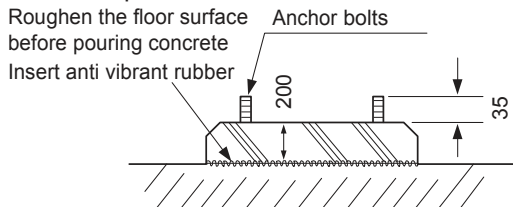

<Foundation dimensions>

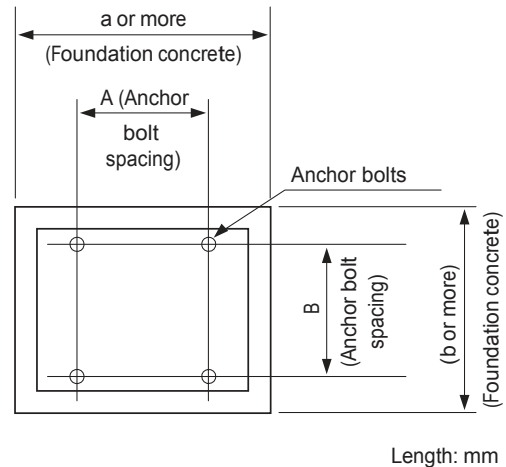

Installation location/ Designed earthquake resistance	Foundation dimensions (mm)		Anchor bolt spacing (mm)	
	a	b	A	B
Ground/ Horizontal 0.4 G, Vertical 0.2 G	1450	1050	743	956
Roof-top/ Horizontal 1.0 G, Vertical 0.5 G	1650	1600	743*	956*



\* Foresee the installation of an antivibrant mount.

#### Important reminder

- **If the foundation is smaller than the specified dimensions or if the designed earthquake resistance value needs to be higher than that shown in the table above, appropriate design change such as connecting the foundation to the building (floor slab) with steel rods is necessary. Such design changes should be done in accordance with the appropriate building equipment seismic tolerance design and installation policy.**



## 2) Anchor bolts

 <b>Warning</b>	
	<ul style="list-style-type: none"> <li>■ <b>Use anchor bolts that satisfy the specifications shown in the table below. Make sure the legs of the outdoor unit are firmly secured with washers and bolts.</b> If the strength is insufficient, the unit could tip over and cause fuel gas leakage or injury.</li> </ul>

### Required anchor bolt pull out resistance strength

Size	M12
Short-term permissible pull-out load	4.6 kN or more
Type	<ul style="list-style-type: none"> <li>• Male mechanical anchor</li> <li>• Resin anchor</li> <li>• Embedded anchor</li> </ul>

- Never use a female mechanical anchor because its pull out resistance strength is insufficient.

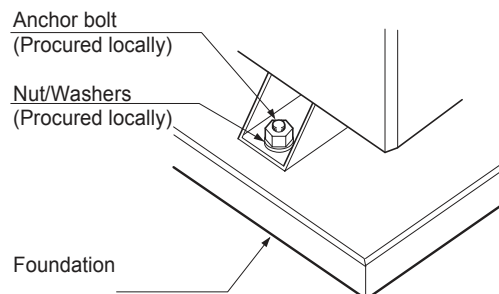

## 3) Antivibrant mount

### Important reminder

- **When using an antivibrant mount to install the unit, check with the relevant local and national regulations and technical standards, and make sure that the installation complies with the building regulations, and required installation policy.**

- Use an antivibrant mount when operating noise or vibration could cause problems in lower floors or nearby rooms as a result of installing the outdoor unit on a roof or balcony. (For specific information about installing, refer to the manual provided with the antivibrant mount.)
- When using the antivibrant mount, provide sufficient grooves in the top of the foundation for draining water so that the draining water will not accumulate inside the lower frame.
- The foundation must be one piece. Make the foundation's upper surface level, flat and smooth so that the lower frame of the antivibrant mount will make even contact.
- The anti vibrant mount can be replaced by using an anti vibrant carpet between the foundation and the surface of the roof.

## 4. Refrigerant Piping

### 4-1. Outline diagram of refrigerant piping

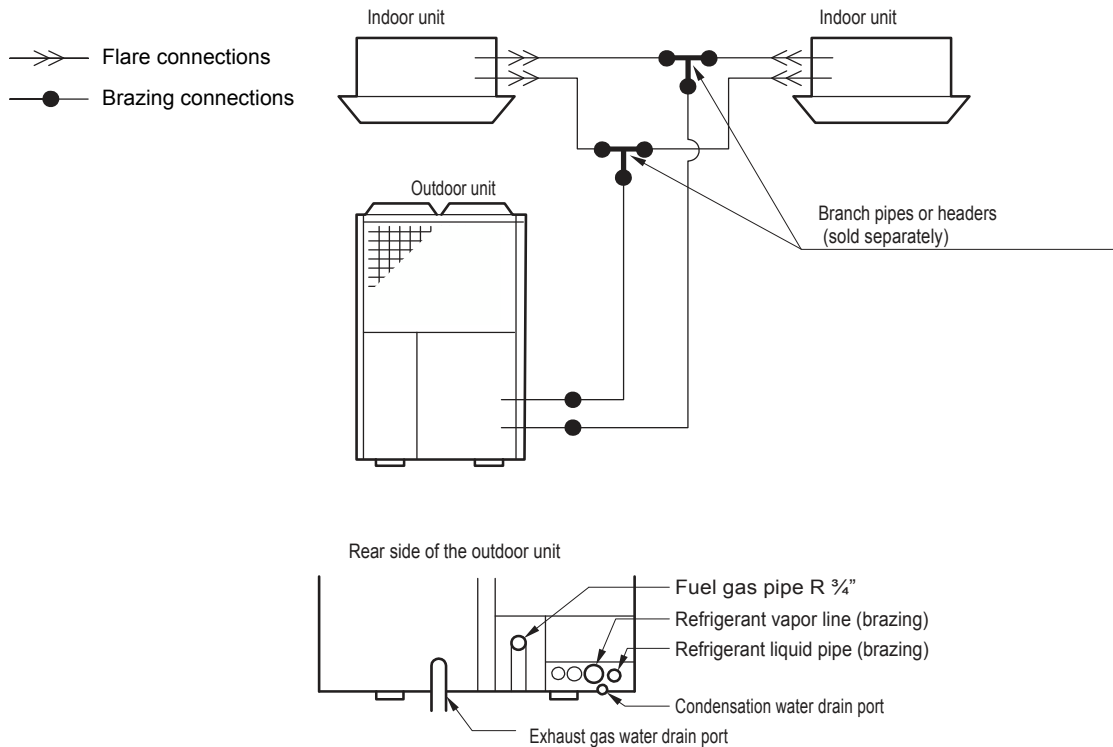

### 4-2. Check existing piping specifications

- Be sure to check piping specifications when reusing existing piping. Replace the piping if the existing piping does not meet the specifications shown in the table below. (Design pressure must be 3.3 MPa or higher.)

Pipe diameter (mm)	C1220T-O materiel or OL material Required minimum thickness (mm)	C1220T-1/2H materiel or H material Required minimum thickness (mm)
ø6.4	0.4	-
ø9.5	0.5	-
ø12.7	0.7	-
ø15.9	0.9	0.5
ø19.1	1.0	0.6
ø22.2	1.1	0.6
ø25.4	-	0.7
ø28.6	-	0.8
ø31.8	-	0.9
ø38.1	-	1.1
ø41.3	-	1.1

- Check the appearance (such as corrosion or deformation) of the pipes when reusing existing piping. If there is any abnormality, replace the piping with new one.
- Use branch pipes with design pressure of 3.3 MPa or higher. If you can not confirm the design pressure, select the branch pipes according to "4-4. Refrigerant piping - Selecting branch pipes and permissible lengths" on page 16.
- If the pipe size is different between existing piping and outdoor and indoor unit piping, connect the pipes using the reducers (procured locally).



### 4-3. Refrigerant piping installation specifications

- Follow the restriction shown in the table below when installing new refrigerant piping.

Outdoor Unit	Item					Refrigerant oil
	Refrigerant main piping diameter (mm)		Permissible piping length (m) Equivalent length/ Actual length	Permissible height difference (m)		
	Vapor line	Liquid line		Outdoor unit is higher	Outdoor unit is lower	
P224	ø19.1 *1(ø22.2)	ø9.5 *1(ø12.7)	190 /165 *2	50	40	NL10
P280	ø22.2 *1(ø25.4)	ø9.5 *1(ø12.7)				
P355	ø25.4 *1(ø28.6)	ø12.7 *1(ø15.9)				

\*1 If the piping length exceeds 100 m, install pipes larger by one rank specified in ( ).

\*2 When total capacity of connected indoor unit exceeds 130 % of rated capacity, restrict the permissible piping length (actual length) to 100 m or less.

### 4-4. Refrigerant piping - Selecting branch pipes and permissible lengths

- \* Follow the piping specification shown below when installing new refrigerant piping. When reusing existing piping, confirm that the existing piping meets the pipe specification shown in “4-2. Check existing piping specifications” on page 14.
- Make sure that the total extension refrigerant piping length is 520 m or less.
- If the refrigerant piping equivalent length exceeds 100 m, use pipes with diameters larger by one rank indicated in “4-3. Refrigerant piping installation specifications” on the previous page for the main liquid and vapor piping.  
Example: ø 12.7 → ø 15.9
- This unit uses R410A. Limit pressure of O material pipe with ø 19.1 diameter or larger is insufficient. Be sure to use 1/2H or H material pipes with minimum thickness or thicker. For ø 19.1 pipe only, however, as long as the thickness is 1.05 mm or greater, O materials can be used.
- Do not use a bent pipe with an external diameter of ø 28.6 or larger.
- Method of refrigerant piping can be selected from line branching, header branching, and line-header combined branching. Select the proper method according to the layout of indoor units.
- Refrigerant piping length and the height difference between indoor units should be arranged as short as possible.
- Re-branching after the header branching is not allowed.

#### ■ Piping specifications (Use the following pipes)

- Piping material: Phosphate deoxidized copper seamless air-conditioning pipe JIS H3300, C1220T (Japanese technical standard) or equivalent.
- Refrigerant pipe specifications: Outer diameter × thickness (mm)
 

ø 6.4 × 0.8 (O material or OL material)	ø 9.5 × 0.8 (O material or OL material)
ø 12.7 × 0.8 (O material or OL material)	ø 15.9 × 1.0 (O material or OL material)
ø 19.1 × 1.0 (1/2H or H material) *1	ø 22.2 × 1.0 (1/2H or H material)
ø 25.4 × 1.0 (1/2H or H material)	ø 28.6 × 1.0 (1/2H or H material)
ø 31.8 × 1.1 (1/2H or H material)	ø 38.1 × 1.35 (1/2H or H material)

\*1 For ø 19.1 pipe only, as long as the thickness is 1.05 mm or greater, O materials can be used.

Note) Refrigerant piping diameter must not exceed the outdoor unit main piping diameter.

(1) 【Main piping】 Between outdoor unit and first branch (A on the following page)			
Outdoor unit	P224	P280	P355
Vapor line (mm)	ø19.1	ø22.2	ø25.4
Liquid line (mm)	ø9.5		ø12.7

(2) Piping between branches (B, C on the following page)					
Total capacity of downstream indoor units (kW)	Less than 22.4	22.4 or more and less than 33.0	33.0 or more and less than 47.0	47.0 or more and less than 71.0	71.0 or more
Vapor line (mm)	ø15.9	ø22.2	ø28.6		ø31.8
Liquid line (mm)	ø9.5		ø12.7	ø15.9	ø19.1

(3) Piping between branch and indoor unit (a, b, c, d, e and f on the following page)				
Indoor unit	P22,28,36,45,56	P71,90,112,140	P224	P280
Vapor line (mm)	ø12.7	ø15.9	ø19.1	ø22.2
Liquid line (mm)	ø 6.4	ø 9.5		

### Important Reminder

- In the case of connection with AWS always remember only single unit installation is allowed. No branches nor headers are allowed as well as simultaneous connection of AWS and indoor units.

### AWS line connection

Layout example (When AWS is connected)			
Permissible piping length	Maximum piping length (L) (Equivalent length/ Actual length)	L = A	70/60 m or less
Permissible height difference	Height difference between AWS unit and outdoor unit (H)	When outdoor unit is higher than indoor unit	25 m or less
		When outdoor unit is lower than indoor unit	20 m or less

### Warning



- Always refer to AWS installation manual for maintenance clearance and position of the unit.
- Always connect the AWS to the designed outdoor unit for AWS.
- Never exceed the maximum allowed distance between AWS and GHP. Failure in doing so can result in malfunctioning of the units and invalidates the warranty.



**Important Reminder**

- In the case of header branching or line-header combined branching, indoor units with capacity of P280 or larger cannot be connected after the header branching (c, d, e or f in the right figure). Connect the indoor units with capacity of P280 or larger to line branching (a or b in the right figure).

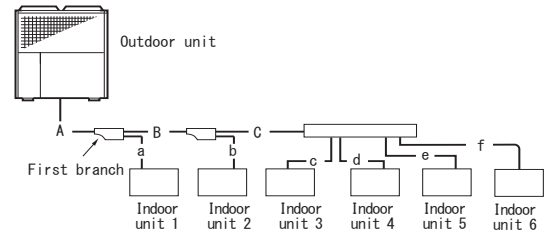

■ Selecting branch piping and permissible piping length

Line branching

Layout example  
(When 6 indoor units are connected)

Note: If there is a height difference between the locations of indoor and outdoor units, apply a small “trap pipes” only on the vapor line at least every 10 m as illustrated.

Permissible piping length	Maximum piping length (L) (Equivalent length/ Actual length)	$A + B + C + D + E + f$	190/165 m or less
	Maximum piping length after the first branch ( $\ell$ )	$B + C + D + E + f$	60 m or less
	Piping length difference after the first branch (when a is the shortest length after the first branch)	$\ell - a$	40 m or less
Permissible height difference	Height difference between indoor unit and outdoor unit (H)	When outdoor unit is higher than indoor unit	50 m or less
		When outdoor unit is lower than indoor unit	40 m or less
	Height difference between indoor units (h)		15 m or less

**Branch piping**

How to select the branch piping kit

- Refer to the following table to select the branch piping kit because the size of branching pipe varies depending on the total capacity of connected indoor units (total capacity of the downstream indoor units).

Classification	Branch piping kit type	
First branch for outdoor unit capacity (kW)	22.4 / 28.0	KHRP26A33T
	35.5	KHRP26A72T
Second branch and after for downstream indoor unit total capacity (kW)	less than 22.4	KHRP26A22T
	22.4 or more and less than 33.0	KHRP26A33T
	33.0 or more and less than 71.0	KHRP26A72T
	71.0 or more	KHRP26A73T

Important reminder:

- Be sure to use the indoor unit piping and indoor branch piping that correspond to the indoor unit connecting piping size.
- Always install the branch piping joint (both for vapor and liquid) so that the joint branches either horizontally or vertically. (Refer to “4-6. Notes for branch piping” on page 24.)

\* When total capacity of connected indoor unit exceeds 130 % of rated capacity, restrict the permissible piping length (actual length) to 100 m.



Line - header combined branching

Layout example  
(When 6 indoor units are connected)

Note: If there is a height difference between the locations of indoor and outdoor units, apply a small “trap pipes” only on the vapor line at least every 10 m as illustrated.

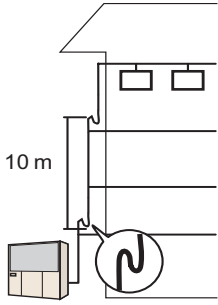

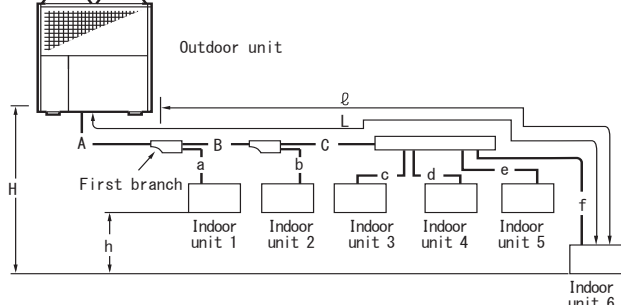

Permissible piping length	Maximum piping length (L) (Equivalent length/Actual length)	A + B + C + f	190/165 m or less
	Maximum piping length after the first branch ( $l$ )	B + C + f	60 m or less
	Piping length difference after the first branch (when a is the shortest length after the first branch)	$l - a$	40 m or less
Permissible height difference	Height difference between indoor unit and outdoor unit (H)	When outdoor unit is higher than indoor unit	50 m or less
		When outdoor unit is lower than indoor unit	40 m or less
	Height difference between indoor units (h)		15 m or less

**Branch piping**

How to select the branch piping kit

- Refer to the following table to select the branch piping kit because the size of branching pipe varies depending on the total capacity of connected indoor units (total capacity of the downstream indoor units).

Classification	Branch piping kit type	
First branch for outdoor unit capacity (kW)	22.4 / 28.0	KHRP26A33T
	35.5	KHRP26A72T
Second branch and after for downstream indoor unit total capacity (kW)	less than 22.4	KHRP26A22T
	22.4 or more and less than 33.0	KHRP26A33T
	33.0 or more and less than 71.0	KHRP26A72T
	71.0 or more	KHRP26A73T

Important reminder:

- Be sure to use the indoor unit piping and indoor branch piping that correspond to the indoor unit connecting piping size.
- Always install the branch piping joint (both for vapor and liquid) so that the joint branches either horizontally or vertically. (Refer to “4-6. Notes for branch piping” on page 24.)

How to select the header piping kit

- Connect crimp piping (locally procured) to the branching points (on the indoor unit connection side) in accordance with the number of connecting indoor units.
- Refer to the header branching kit (sold separately) for the crimp piping size.

Total capacity of downstream indoor units (kW)	Header kit type	Number of branches
less than 22.4	KHRP26M22H	Up to 4 branches
22.4 or more and less than 33.0	KHRP26M33H	Up to 8 branches
33.0 or more and less than 71.0	KHRP26M72H	
71.0 or more	KHRP26M73H	

Important reminder:

- Be sure to use the header branching and indoor unit piping that correspond to the indoor unit connecting piping size.
- Always install the header branching joint (both vapor and liquid sides) so that the joint branches horizontally. (Refer to “4-6. Notes for branch piping” on page 24.)
- Re-branching after the header branching is not allowed. Besides, the indoor unit with capacity of P280 or larger can not be connected after the header branching.

\* When total capacity of connected indoor unit exceeds 130 % of rated capacity, restrict the permissible piping length (actual length) to 100 m.

## 4-5. Precautions during the installation of refrigerant piping

### 1) Precautions against refrigerant leakage

 **Warning**



- **Check that the refrigerant never exceeds the limit concentration in the room even if the refrigerant vapor leaks inside the room.**  
 If the refrigerant concentration in the room should exceed the limit concentration, an accident due to lack of oxygen could occur. The refrigerant concentration is calculated as follows.

$$\frac{\text{Total amount of refrigerant in the refrigerant equipment (kg)}}{\text{Minimum indoor volume of the room in which the indoor unit is installed (m}^3\text{)}} \leq \text{Limit concentration (kg/m}^3\text{)}$$
- If the calculated concentration exceeds the limit concentration, an opening to the next room to make the calculated concentration lower than the limit or a mechanical ventilation system linked to a gas leakage detector must be provided.
- **Be sure to check for refrigerant gas leakage surely.**  
 Although the refrigerant is non-flammable, non-toxic and odorless fluorocarbon, in the event of fluorocarbon leakage, toxic gas may be produced from contacting with fire. Moreover, since the specific gravity of fluorocarbon is heavier than that of air, it could cause an accident due to lack of oxygen from covering the floor surface.

- The limit concentration is the threshold that the emergency procedures can be performed without affecting the human body when refrigerant has leaked into the air.

**Limit concentration: 0.3 kg/m<sup>3</sup>**

- At the time of shipping, the outdoor unit has already been charged with the refrigerant shown below. To calculate the total amount of refrigerant, add the amount of refrigerant charged at the installation site to the amount charged at factory.

Outdoor unit	Refrigerant type	Charged amount of refrigerant (at the time of shipping) (kg)
P224	R410A	11.0
P280		
P355		

- A reference for the minimum room volume and floor area in relation to the refrigerant amount is shown in the right graph. If the calculated concentration exceeds the limit concentration, be sure to take either of the following countermeasures.

**Countermeasure1:**



Provide an opening whose area is 0.15 % or more of the floor area at the bottom of each door. Or, provide an opening without a door.

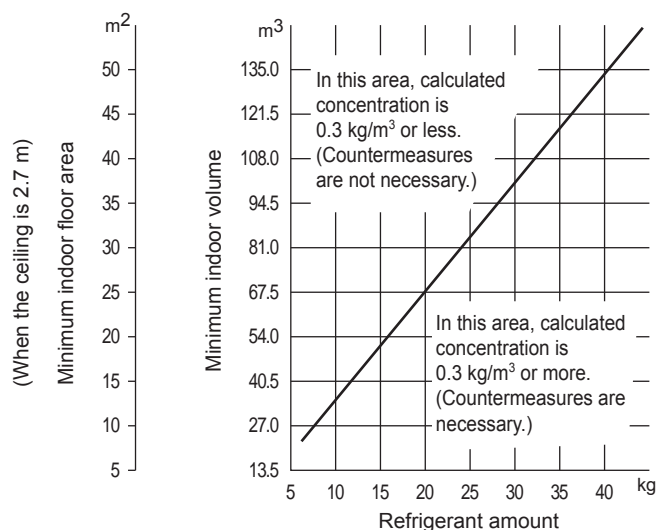

**Countermeasure2:**

Provide a mechanical ventilation system linked to a gas leakage detection device.



## 2) General precautions

 <b>Warning</b>	
	<ul style="list-style-type: none"> <li>■ <b>This equipment uses non-flammable refrigerant, R410A exclusively. Never charge with other refrigerant, air, oxygen, propane, or other materials.</b> Doing so could cause an explosion or a fire.</li> </ul>
	<ul style="list-style-type: none"> <li>■ <b>Be sure to remove any flammable materials before brazing.</b> Failure to do so could cause a fire.</li> <li>■ <b>Be sure to use non-flammable and non-toxic cleaning liquid for washing.</b> Using an flammable cleaning liquid could cause an explosion or a fire.</li> <li>■ <b>Be sure to provide adequate ventilation when installing the refrigerant piping because installation in a tightly closed place could cause an accident due to lack of oxygen.</b> If a cleaning liquid contacts fire, it can create toxic gas.</li> </ul>

 <b>Caution</b>	
	<ul style="list-style-type: none"> <li>■ <b>Be sure to collect the cleaning liquid after washing.</b> Indiscriminate chlorofluorocarbon (CFC) emission into the atmosphere is prohibited by law. Dispose of the refrigerant as required by relevant local and national regulations.</li> </ul>

**Important reminder**

- **The R410A specification requires stringent control of impurities, such as moisture and foreign material. The following precautions must be strictly followed during installation in order to prevent damage to the equipment.**
- **During brazing, always supply nitrogen gas through the piping. Brazing without supplying nitrogen gas can create oxide film and cause equipment breakdown.**
- **Do not use any antioxidant sold on the market. It may have an adverse effect on the refrigerant and refrigerant oil, resulting in equipment breakdown.**

## ■ Refrigerant piping installation

- During the installation of the piping, always close off the ends of the piping with tape or caps to prevent moisture, dust or other impurities from entering.
- Always sufficiently flush the inside of the piping with nitrogen gas to remove foreign object, moisture and other impurities.
- Always use a pipe cutter to cut the pipes.
- Inside of cut sections has burrs. Always remove these burrs before flare processing.
- **In order to prevent oxide film from forming inside the piping during brazing, always braise with nitrogen gas flowing through the piping with a pressure reduction valve. The appropriate nitrogen gas pressure is 0.02 MPa. (You feel breeze on your cheek at this pressure.)**
- **When supplying nitrogen gas through the piping during brazing, ensure that the end of the pipe that the nitrogen is flowing into is sealed to prevent air from entering.**
- Route the refrigerant piping so as to provide a space for servicing.

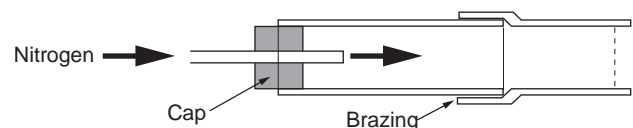

■ Sealing test and vacuuming

- In order to prevent mixing of other refrigerant or refrigerant oil, be sure to use a gauge manifold, charging hose and vacuum pump that are exclusively for R410A.
- Be sure to perform a sealing test. If R410A leaks, there is a possibility that the composition of the refrigerant inside the equipment will change. If there is a leak, the refrigerant must be recovered and then recharged. Do not perform additional charging. (See “4-8. 1) Refrigerant vapor leakage test” on page 26.)
- Since systems with R410A are much more susceptible to damage from moisture than systems with the previous type of refrigerant, always perform a thorough vacuuming (drying) to prevent equipment breakdown. (See “4-8. 2) Vacuuming with a vacuum pump” on page 27.)

■ Charging refrigerant

- Never charge R410A as a vapor. Always charge as a liquid. Charging as a vapor may cause a compositional change of the refrigerant, and could result in a performance decline or a breakdown.

■ Notes when doing flare process

The R410A flare dimensions differ from the previous R407C dimensions. We recommend using the R410A flare tool, but if the protrusion amount B can be adjusted with the protrusion adjusting gauge, the old tool can be used.

Flare pipe end: A (mm)

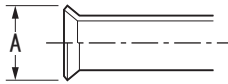

Copper pipe outer diameter	<b>A</b>
	0 -0.4
ø 6.4	9.1
ø 9.5	13.2
ø 12.7	16.6
ø 15.9	19.7
ø 19.1	24.0

Protrusion amount of copper pipe for flare process: B (mm)

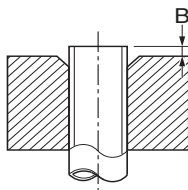

Copper pipe outer diameter	In the case of rigid (clutch)	
	When using the R410A tool	When using the old tool
ø 6.4	0 to 0.5	0.7 to 1.3
ø 9.5		
ø 12.7		
ø 15.9		
ø 19.1		

■ Precautions when connecting flare nuts

 **Warning**



■ **Tighten the flare nuts with an open-end wrench and a torque wrench to check that the tightening torque is proper.**

If the torque is not proper, the refrigerant may leak and cause an accident due to lack of oxygen due to broken or loosened joints.

Flare nut tightening torque

Outer diameter (mm)	Nominal diameter (inch)	Flare tightening torque (N.m)
6.4	1/4	14 to 18
9.5	3/8	34 to 42
12.7	1/2	49 to 61
15.9	5/8	68 to 82
19.1	3/4	100 to 120

- If you have no choice but to tighten the flare nut without a torque wrench, tighten the nut from the point where the tightening torque increases by the angle shown below as a guide.

Tightening angle

Pipe diameter	Tightening angle
∅ 6.4, ∅ 9.5	60° to 90°
∅ 12.7, ∅ 15.9, ∅ 19.1	30° to 60°

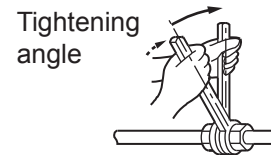

- Apply refrigerant oil lightly to the inner surface of the piping joint sheet before tightening the flare nut.

■ Others

- The refrigerant oil absorbs moisture from the air. The following notes must be observed when refrigerant oil refilling is necessary for service.
  - Perform charging operation as quick as possible.
  - Open the container lid immediately before using.
  - Discard any oil remaining after use.
  - Keep the lid of the container tightly closed when the refrigerant oil is temporarily stored during the charging operation.
- Refrigerant piping cure for storage (Curing method)
 

Be sure to cure the end of piping to prevent any moisture, dirt, and dust. Failure to do so may cause a serious trouble due to moisture intrusion.

Storage location of refrigerant piping	Storage period	Curing method of the piping end
Outdoor	1 month or more	Pinching
	Less than 1 month	Pinching or Taping
Indoor	-	Pinching or Taping

(Curing Method)

① Pinching

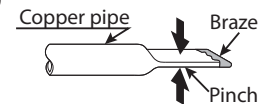

② Taping

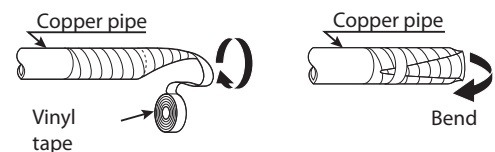

## 4-6. Notes for branch piping

### Important reminder

- When connecting the branch pipe, do not bend the main pipe near the connection.**  
**If such bending is unavoidable, provide a minimum of 150 mm of straight portion.**  
**However, do not use a bent pipe with an external diameter of  $\phi 28.6$  or larger.**

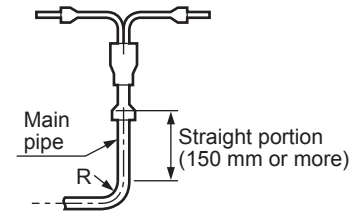

- Do not perform another branching after the header branching.
- When performing header branching, connect the crimp pipe (locally procured) in accordance with the number of indoor units connected.

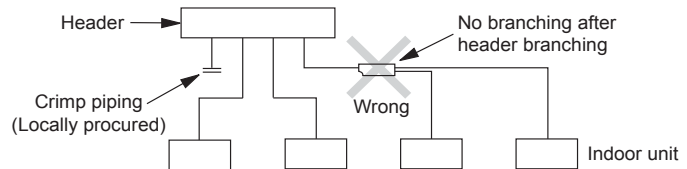

- Always install line branch pipes to make either "vertical branching" or "horizontal branching" for both vapor and liquid lines.

	Horizontal			Vertical	
	Correct	Wrong	Wrong	Correct	Correct

- Always install header branch pipes to make "horizontal branching" for both vapor and liquid lines.

	Horizontal		
Vapor line			
	Correct	Wrong	Wrong
Liquid line			
	Correct	Wrong	Wrong



## 4-7. Stop valve connections and opening / closing

### 1) Stop valve connections

- Both of liquid and vapor line pipings must be brazed when connecting.

#### Important reminder

- Connect refrigerant piping with the stop valves on the outdoor unit fully closed (factory default). Do not operate the stop valves until all the refrigerant piping for the indoor and outdoor units has been connected, and the refrigerant leakage test, vacuuming operation and additional refrigerant charging has been completed. Note that both the vapor and liquid line valves must be fully open in operating.
- Take extra care not to damage the power supply wire, communication wire, condensation water drain port, or exhaust water drain hose by brazing flame when brazing the refrigerant pipes to the stop valves.

### 2) Opening and closing the stop valves

- Open the liquid line stop valve first, then open the vapor line stop valve.

- Remove the cap.
- Turn the valve shaft by 90° counterclockwise with an open-end wrench. The valve is fully opened at the position where the pin hits the stopper.
- Firmly tighten the cap.

< Liquid / Vapor >

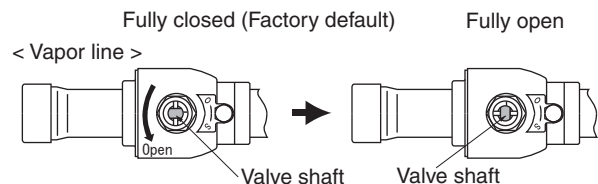

Liquid line	10 to 15 N•m
Vapor line	26 to 32 N•m

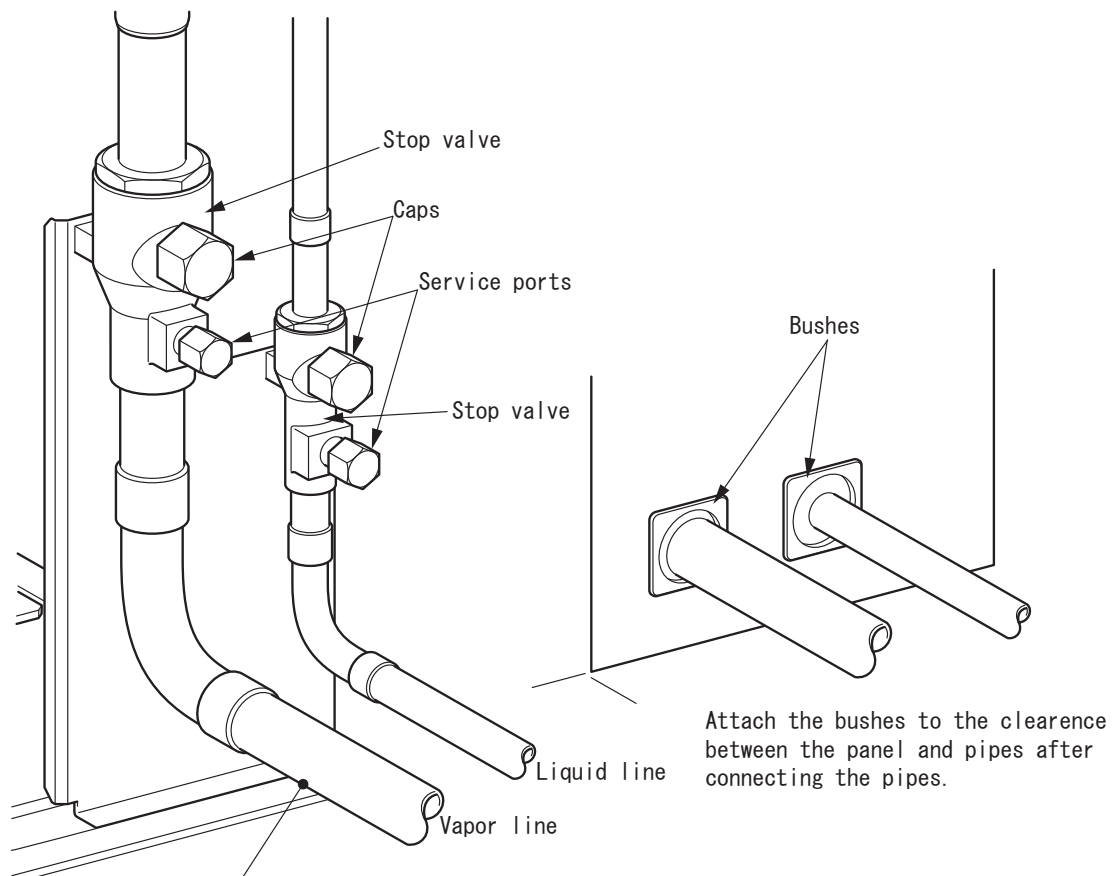

Braze these pipes to the connection pipes provided locally.  
(Be sure to supply nitrogen gas from the service ports when brazing.)

## 4-8. Refrigerant vapor leakage test and vacuuming

### 1) Refrigerant vapor leakage test

#### Warning



- **After the refrigerant piping has been installed, always perform a sealing test to confirm that no refrigerant vapor is leaking.**

If the refrigerant should leak and the refrigerant vapor exceeds the limit concentration, it could cause an accident due to lack of oxygen.

1. Remove the service port caps of the stop valves. Connect the gauge manifold as shown in the illustration below. Open V1, V2 and V3 and pressurize with nitrogen gas.
  - Keep the stop valves closed. Always pressurize both the liquid and vapor pipings.
  - The test pressure must be 37bar (3.7MPa) for standard GHP unit and 33bar (3.3MPa) for renewal GHP unit.
2. Slowly increase the pressure to the specified pressure. Do not increase the pressure quickly.
  - a) Once 0.5 MPa is applied, hold the pressure and let stand for 5 minutes or more. Check that there is no pressure drop.
  - b) Next, increase the pressure to 1.5 MPa and again let stand for 5 minutes or more. Confirm that the pressure does not drop.
  - c) After that, increase the pressure to the specified value and note the ambient temperature and pressure.
  - d) Let stand at the specified pressure for one day. If there is no pressure drop, the system is OK. If the ambient temperature changes by 1 C°, the pressure changes 0.01 MPa accordingly. Judge if there is refrigerant leakage taking account of temperature change before and after the leakage test period.
  - e) If a drop in pressure is detected through steps a-d, there is a leakage. Apply soapy solution to the welded sections and flare joints to determine the leaking section's locations and then fix them. Perform the leakage test again once the leaks have been fixed.

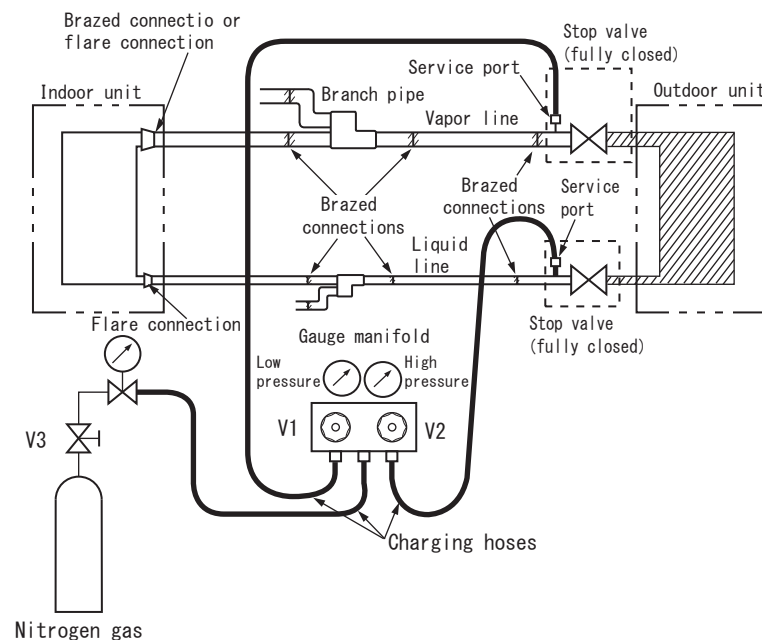

## 2) Vacuuming with a vacuum pump

**Important reminder**

- Vacuuming must be performed with the stop valves on the outdoor unit "fully closed".
- Do not perform an air purge with the refrigerant inside the outdoor unit or the refrigerant tank.
- Use a vacuum pump which is able to attain pressure lower than -101 kpa (-755 mmHg).

Apply vacuuming at the both service ports of the liquid and vapor line stop valves.

<Operation Flow>

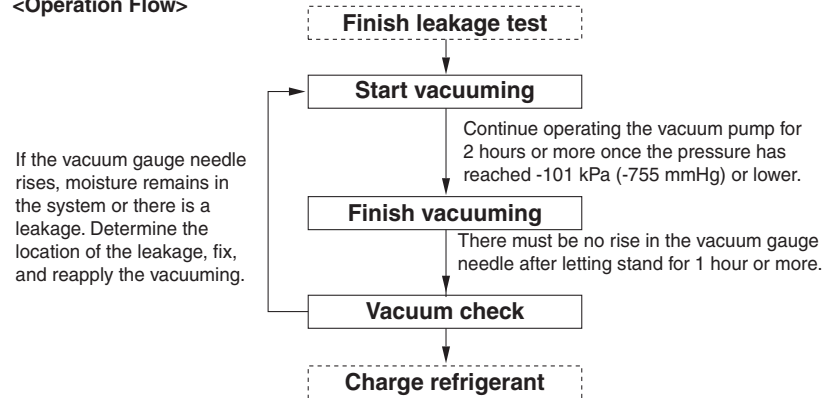

**【When there is a possibility of moisture intrusion in piping】**

- ① Increase the pressure to 0.05 Mpa with nitrogen gas after vacuuming for 2 hours or more.
- ② Then, perform vacuuming again for 1 hour or more and make sure the pressure has reached -101 kpa.
- ③ If the pressure does not reach -101 kpa after 2 hours of vacuuming, repeat steps ① and ② until the pressure reaches -101 kpa.
- ④ After the pressure has reached -101 kpa or lower, let stand for 1 hour and make sure that the pressure of the vacuum gauge does not rise.

\* Meaning of the possibility of moisture intrusion in piping

Apply the procedure above when there is any possibility of internal condensation or rainwater intrusion inside the refrigerant piping arising from long construction period during rainy weather like in the rainy season.

(Note) Keep the following points in mind, for this unit is an R410A model.

- To avoid cross-contamination with other types of oil, make sure to separate maintenance tools according to the type of refrigerant used. In particular, never use the same gauge manifold and charge hose with other refrigerants (R22, R407C etc.).
- Use a backflow prevention adapter to prevent vacuum pump oil from entering the refrigeration system.

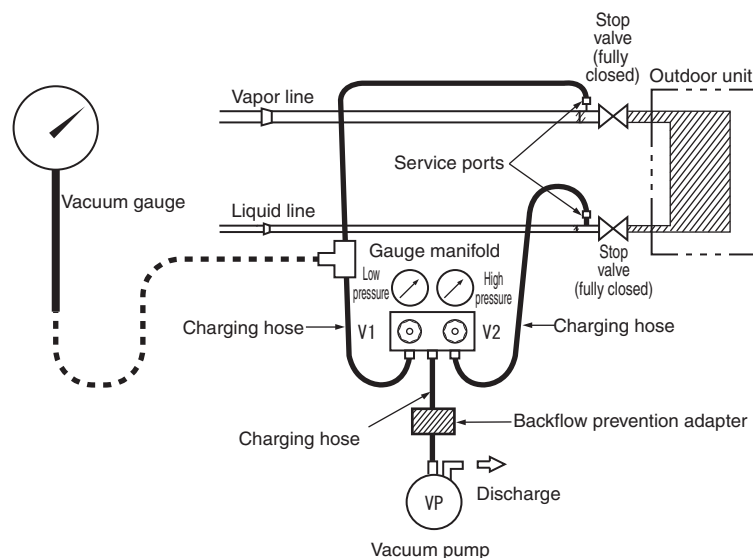

## 4-9. Refrigerant charging

### Important reminder

- When charging the refrigerant, accurately measure the length of the piping and charge the proper amount of refrigerant. If the amount of refrigerant is not proper, performance will decline or a breakdown could occur.
- After completion of refrigerant charging, write down the installation record on the plate "POINTS FOR INSTALLATION" inside the outdoor unit control box panel. Besides, calculate the refrigerant amount for the whole system and write down the amount on the plate. Calculation formula is shown on the plate. (Write with a permanent marker so that the record does not disappear easily.)

### 1) Refrigerant charging amount

Always check the refrigerant gas factory charge on the unit label before calculating the amount to be added. Calculate the amount of refrigerant to be charged according to the following formula and liquid piping length for each size of the piping.

[When the GHP is connected to direct expansion indoor units]

$$\text{Charge amount (kg)} = (\ell_1 \times 0.353) + (\ell_2 \times 0.250) + (\ell_3 \times 0.170) + (\ell_4 \times 0.110) + (\ell_5 \times 0.054) + (\ell_6 \times 0.022) + Q_{de}$$

Where  $Q_{de}$  depends on the number of connected indoor units or the size of the AHU according to the table below.

[When the GHP is connected to YOSHI AWS E1]

$$\text{Charge amount (kg)} = (\ell_1 \times 0.353) + (\ell_2 \times 0.250) + (\ell_3 \times 0.170) + (\ell_4 \times 0.110) + (\ell_5 \times 0.054) + (\ell_6 \times 0.022) + Q_{aws}$$

$\ell_1$ : Liquid piping  $\varnothing$  22.2 total length (m)     $\ell_2$ : Liquid piping  $\varnothing$  19.1 total length (m)     $\ell_3$ : Liquid piping  $\varnothing$  15.9 total length (m)

$\ell_4$ : Liquid piping  $\varnothing$  12.7 total length (m)     $\ell_5$ : Liquid piping  $\varnothing$  9.5 total length (m)     $\ell_6$ : Liquid piping  $\varnothing$  6.4 total length (m)

Type of indoor system	$Q_{de}$ [kg]	$Q_{aws}$ [kg]
Direct expansion single indoor unit	0,0	-
Direct expansion multiple indoor unit	1,0	-
Direct expansion air handling unit AHU	Refer to manufacturer specification	-
Air water system YOSHI AWS	-	0,0

### 2) Refrigerant charging method

#### Caution



- When charging the refrigerant, be sure to wear a pair of leather gloves. If the refrigerant touches your skin directly, it may cause a frostbite.

### Important reminder

- Always charge the refrigerant as a liquid in the tank. Charging as a vapor may cause a compositional change of the refrigerant, and could result in a performance decline or a breakdown.
- Always use a refrigerant scale when charging the refrigerant. Using a charging cylinder may cause a compositional change of the refrigerant, and could result in a performance decline or a breakdown.
- To avoid cross-contamination with other oil types, make sure to separate maintenance tools according to the type of refrigerant used. In particular, never use the gauge manifold and charging hose with other refrigerants (R22, R407C etc.).

1. Place the tank (with the siphon pipe attached) on the refrigerant scale.
2. Remove the charging hose from the vacuum pump and connect it to the tank.
3. Perform an air purge of the inside of the charging hose from the tank to the gauge manifold.
4. Open the valves V2 and V3 and charge the required amount of refrigerant in the liquid phase. After the charging is completed, close the valves V2 and V3.

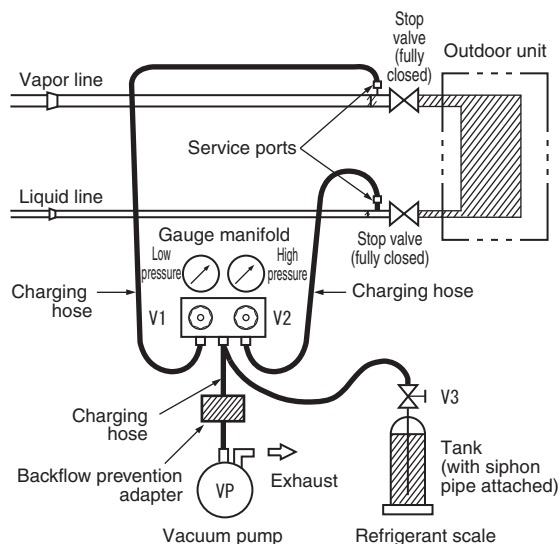

#### 4-10. Refrigerant piping insulation and heat retention

##### ⚠ Caution



- As for refrigerant piping and drain piping, apply insulating material (polyethylene foam, glass wool etc.) of 10 mm or more in thickness, to both of the vapor and liquid line pipings separately. When it exceeds DB 30 °C and RH 65 %, use thicker insulating material than above.

Insufficient insulation work could cause household goods to get wet due to condensation water dripping.

- Retain heat by applying insulating material separately to the vapor and liquid pipings.
- Use insulating material with a heat resistance of 120 °C or more. After the refrigerant gas leakage test has been performed, use dressing tape to wrap the insulation.

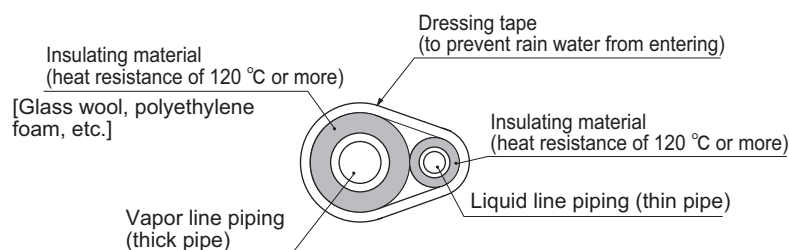

#### 4-11. How to secure refrigerant piping

- If the antivibration mount is used, the distance to the first fixed point of refrigerant piping must be at least  $L = 1.5$  m.

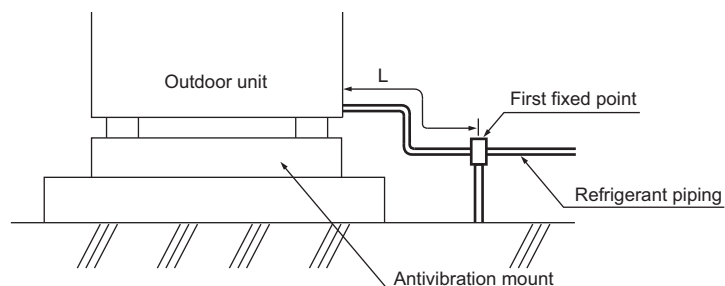

## 5. Fuel Gas Piping Installation

### Warning



- **Use only the fuel gas indicated on the name plate.**  
Using wrong type of fuel gas could cause incomplete combustion or could damage the outdoor unit.
- **Always perform a gas leakage test after connecting the piping.**  
In there should be a gas leakage, a fire or an explosion could occur.
- **Use soapy water or a gas leakage detector for performing the gas leakage test.**  
Using a flame reaction test could cause a fire or an explosion.
- **Always use a reinforced gas hose between the gas valve on the fuel gas piping and outdoor unit.**  
Failure to do so could cause a gas leakage.
- **Install the piping so that the fuel gas pressure at the inlet port of the outdoor unit is equal to the pressure required by the gas supply standard defined by the gas suppliers.**  
Incorrect pressure of fuel gas could cause incomplete combustion or malfunction of the unit.

### Important reminder

- **Do not apply pressure of over 42 mbar (4.2 kPa) when testing the fuel gas line for leakage.**  
Doing so could damage the regulator inside the unit.

- The gas piping for the outdoor unit must be installed as shown in the drawing below.
- The devices shown as 1 and 5 must be installed at all times for service and safety of the fuel system.
- Install the devices shown as 2, 3 and 4 as necessary. These devices are for checking the supplied gas pressure and filtering the gas.

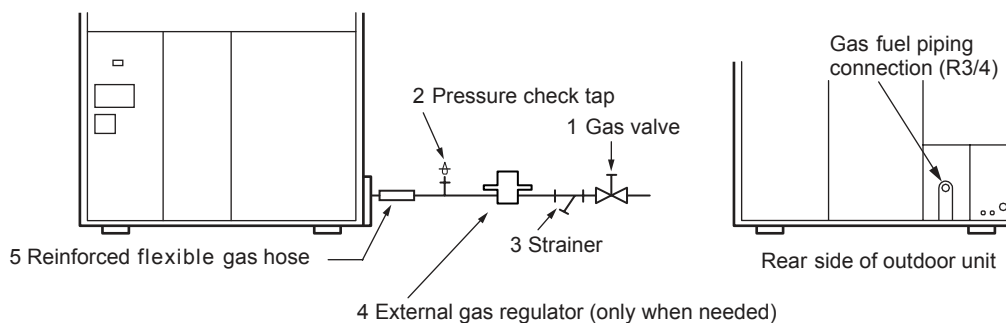

## 6. Drain Piping Installation

### 1) Exhaust water drain piping installation

#### Warning



- **Never share the same pipe between the exhaust drain for the outdoor unit and the exhaust water drain for the indoor unit.**

If exhaust gas flows into the building, it could cause gas poisoning or an accident due to lack of oxygen.



- **Arrange the piping so that the exhaust gas in the exhaust drain is released to the atmosphere in the following cases.**

a) **The exhaust drain hose of the outdoor unit is connected to the catch basin or ditch with a lid.**

b) **The exhaust drain water of the outdoor unit is released at the same location as the drain water of the indoor unit.**

If the exhaust gas is not released into the atmosphere, gas poisoning or an accident due to lack of oxygen could occur.

#### Caution



- **When installing the outdoor unit on a roof, route the exhaust drain for the outdoor unit to the drain for rainwater.**

Routing the exhaust drain directly onto the roof may stain the concrete or damage the waterproof sheet if fitted.

#### Important reminder

- **Extend the exhaust water drain piping to the appropriate outlet as shown on the following page, because condensation water from the exhaust gas drains from the exhaust water drain hose of the outdoor unit.**
- **Always provide downward gradient for the drain piping. Otherwise, the exhaust drain water will accumulate in the piping and damage the unit.**
- **Take care not to clog up the end of the exhaust water drain hose when inserting the hose to the exhaust water drain pipe. Otherwise, the exhaust drain water will accumulate in the hose and damage the unit.**
- **When the drain piping is a combined piping, provide openings (breathers) upstream of the connecting points of the pipes to avoid back pressure.**

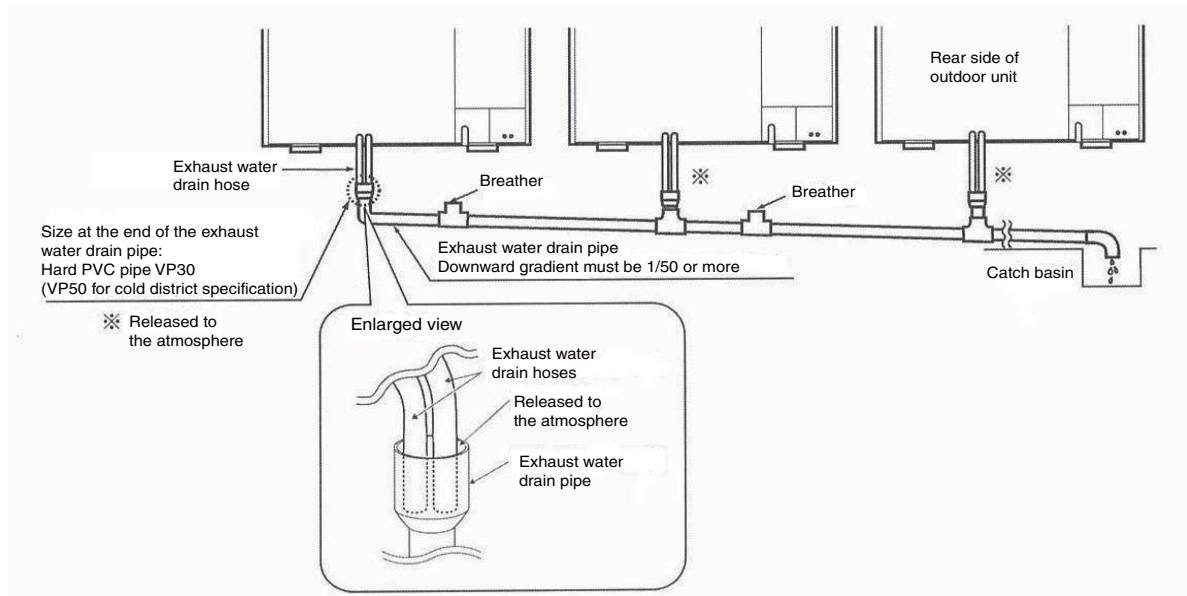

### Important reminder in the cold district

#### [Installation]

- Make antifreezing treatment on the exhaust water drain piping in the cold district (the area where the outside air temperature can fall below 0 °C) to prevent drain water freezing. Drain water freezing will damage the unit.
- **Do not make antifreezing treatment on the pipe where the exhaust water drain hose is inserted. (See below.)** Otherwise, the portion will overheat and damage the unit.

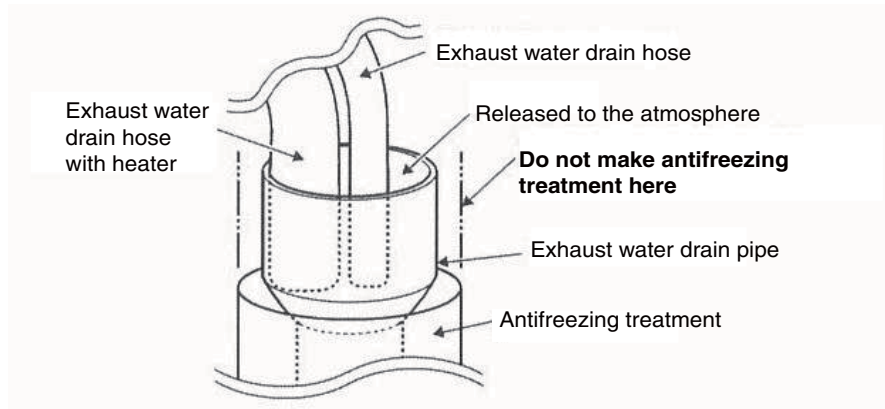

#### [Unit]

- Install an exhaust water drain hose with heater (sold separately) in the cold district (the area where the outside air temperature can fall below 0 °C). Refer to the installation manual attached to the exhaust water drain hose with heater for installation method.
- The cold district specification unit contains the exhaust water drain hose with heater in the engine compartment. Be sure to pull out the hose from the outdoor unit referring to the installation manual attached to the hose. Failing to pull out the hose will damage the unit.



## 2) Condensation water drain piping installation

- Condensation water on the surface of the accumulator will drain from the condensation water drain port. Connect a hose on the market to the condensation water drain port and install the drain piping if there is a problem due to condensation water dripping. In such a case, take appropriate measures such as fixing the end of the hose to prevent the condensation water from reaching the location where the condensation water causes the problem. (If you connect the hose to the hard PVC pipe, prevent the hose from coming off the pipe.)

### [Example of installation]

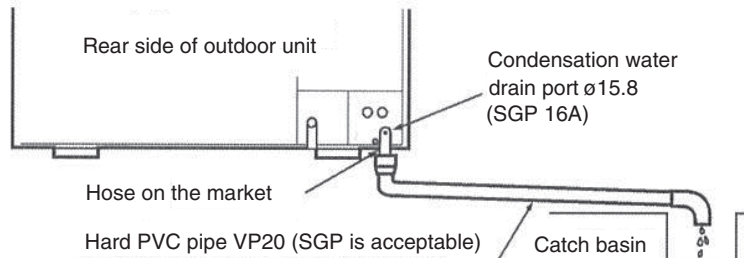

- Avoid sharing the same pipe between the condensation water drain and exhaust water drain as much as possible. If you need to share the same pipe between the condensation water drain and exhaust water drain, be sure to follow the following instructions when installing. Otherwise, exhaust gas could enter the outdoor unit and cause a breakdown.
  - **The joint between the condensation water drain hose and exhaust water drain hose must be released to the atmosphere. (Do not seal up the joint opening with the caulking material or other materials.)**
  - **Provide openings (breathers) upstream of the connecting points of the condensation water drain hose and exhaust water drain hose.**
  - **Be sure to follow the instructions and precautions in “1) Exhaust water drain piping installation” on page 31.**

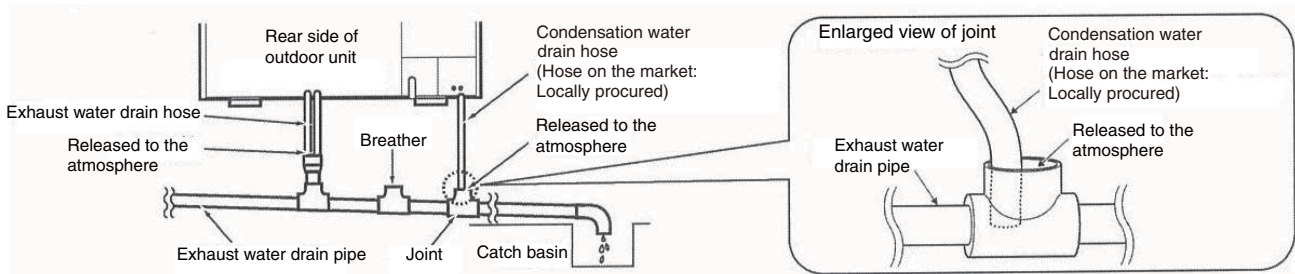

# 7. How to Extend Exhaust Pipe

- Use KP (Kantan (=easy) Pipe) with a diameter of 80 mm for exhaust pipe extension.
- Ask an authorized dealer about KP.

## 1) Precautions for exhaust pipe extension

 **Warning**



- **Do not extend the exhaust pipe to a location where the exhaust gas could potentially enter the indoors.**  
If the exhaust pipe is extended to near the intake/exhaust port to the room, window or ventilation port, the exhaust gas could flow into the room and cause gas poisoning or an accident due to lack of oxygen.
- **Do not extend the exhaust pipe to an area where flammable gas can be produced, flow into, accumulate or leak, or where volatile flammable materials can be treated.**  
Extension to such locations could result in a fire or an explosion.

- **Be sure to discharge the exhaust gas directly to an outdoor area open to the atmosphere.**  
Accumulated exhaust gas could cause gas poisoning or an accident due to lack of oxygen. Install the outdoor unit where adequate ventilation is provided.
- **Be sure to discharge the exhaust gas to the atmosphere where the gas causes no adverse effect to the surroundings.**  
If the exhaust gas is exhausted into the catch basin or ditch, it could be drawn into the room and cause gas poisoning or an accident due to lack of oxygen.
- **Be sure to discharge the exhaust gas to a location where the exhaust gas is not directed toward animals or plants.**  
Exposure to the exhaust gas or discharge air could have harmful influence on animals or plants.
- **Be sure to maintain the appropriate clearance from the flammable or flame resistant material covering building in accordance with the following figure.**  
Inadequate clearance could cause a fire.

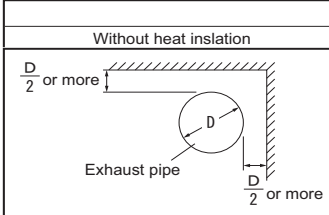
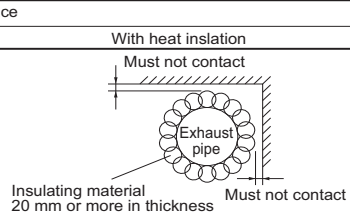

- Distance from the exhaust pipe must be as follows.

Space	
Without heat insulation	With heat insulation
	

- Distance from the top end opening of the exhaust pipe must be as follows.

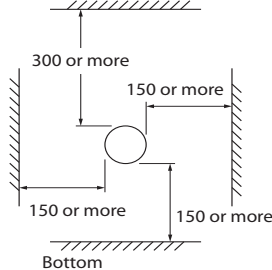

Bottom

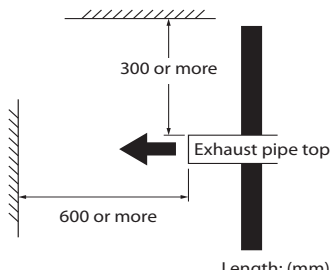

Exhaust pipe top

Length: (mm)

- Try to avoid extending the exhaust pipe in areas where the outside temperature falls to 0 C° or less because the inside of the exhaust pipe may freeze.

## 2) Exhaust pipe extension

- Extended the exhaust pipe according to the following procedure by referring to the figure below.
1. Remove the exhaust top from the outdoor unit exhaust port.
  2. Connect the KP (Kantan Pipe) sequentially from the outdoor unit side, and extend the exhaust pipe to the desired position following the restriction below.
    - Total length of the exhaust pipe extension shall not exceed 10 m.
    - Total number of exhaust pipe bends (bending angle = 90 °) shall not exceed 5.
    - The extended pipe shall be anchored to the building or similar structure with fixing brackets every 1.5 to 2 m.
    - The exhaust pipe shall not be gathered or connected with the other exhaust pipe.
  3. Attach the exhaust top at th outlet of the extended exhaust pipe paying attention to the following:
    - The angle of the exhaust vent plane shall be vertical to the ground by adjusting the elbow pipes so that rain-water may not enter the exhaust pipe directly.
    - Apply silicone caulking material at the lower part of the metal mesh in accordance with the following figure so that the drain water may not drip from the exhaust top. (Refer to the figure below.)

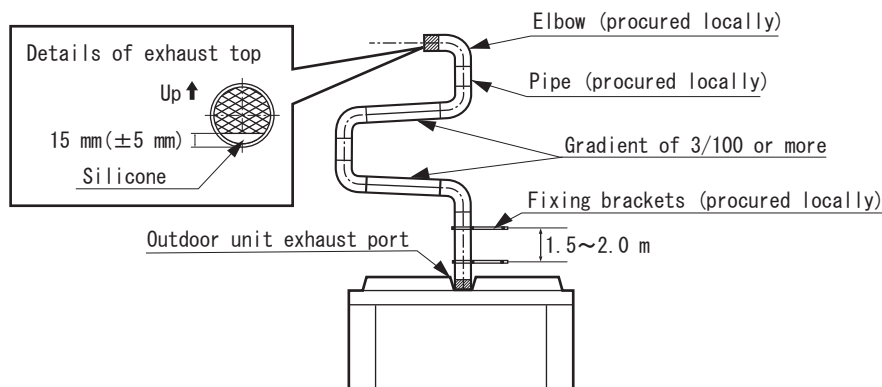

- When installing the outdoor unit on the antivibration mount, the extended exhaust pipe may come off due to the vibration. In such a case, the only acceptable extension is the following.

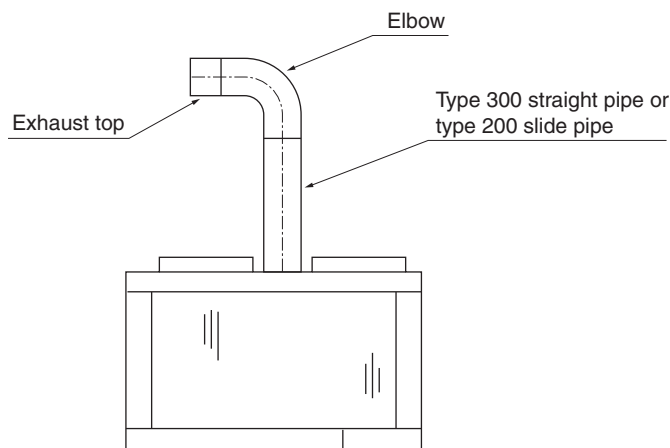

## 3) Installation check

- Make sure that there is no leakage of exhaust gas or exhaust drain water form the exhaust pipe joints by performing test operation after completing the exhaust pipe extension.

## 8. Summary of Electric Wiring Installation

### Warning



- **Use a dedicated branch circuit. Never use the outdoor unit with other appliances on the same circuit.**

If the outdoor unit and other appliances are used on the same circuit, secondary damage could occur due to breaker tripping.



- **All electrical installation work must be performed by a certified electrician in accordance with the relevant local and national regulations, technical standards, and instructions provided in this manual.**

Improper installation could result in electrical shock, fire or other hazards.

- **Provide an electric leakage breaker with the specified capacity for each outdoor unit (sensitivity amperage is 30 mA).**

If the electric leakage breaker is not installed, electrical shock could occur.

- **Provide an over-current breaker with the specified capacity for each outdoor unit.**

If the proper over-current breaker is not installed, overheating, fire or secondary damage due to the breaker tripping could occur.

- **Always use the designated cable for wiring. Make sure that the cable is properly connected and fixed so that the outside forces may not be transferred to the terminal connection.**

Improper connecting or fixing can result in overheating, fire or other hazards.

- **Always ground the unit in accordance with the relevant technical standards.**

Improper grounding can result in electrical shock.

### Important reminder

- **Select an “inverter type” electric leakage breaker that will not be affected by high-frequency leakage currents.**

### 8-1. Opening for power supply wires / signal wires

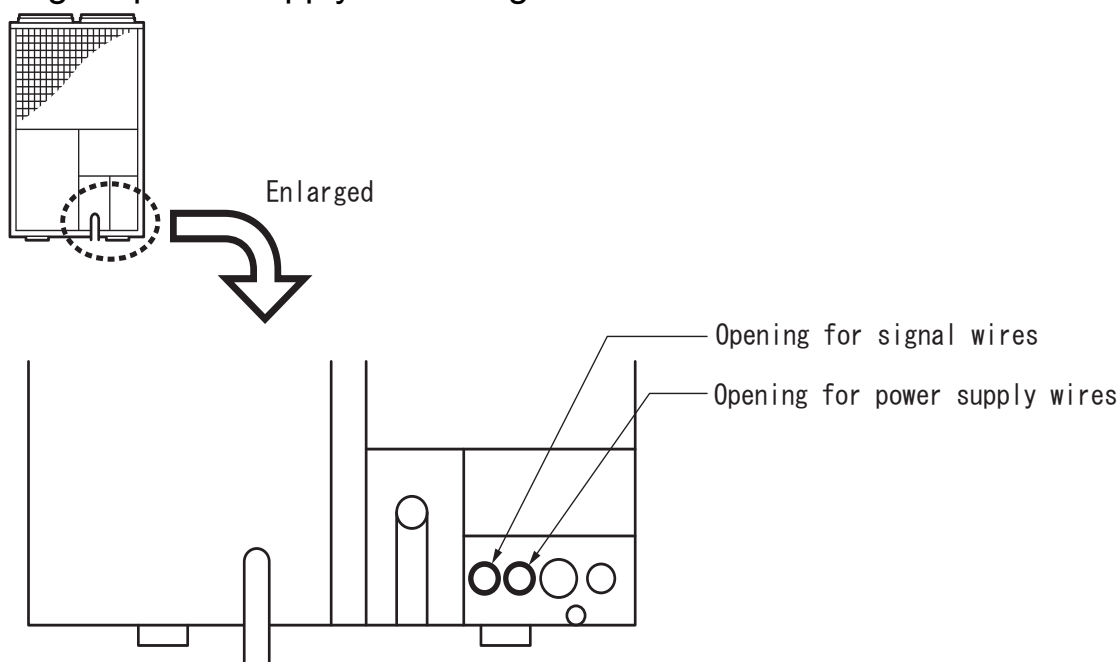

※Bundle power supply wires and signal wires to avoid contact with the pipes.

### 8-2. Wiring example (AC 230V single phase)

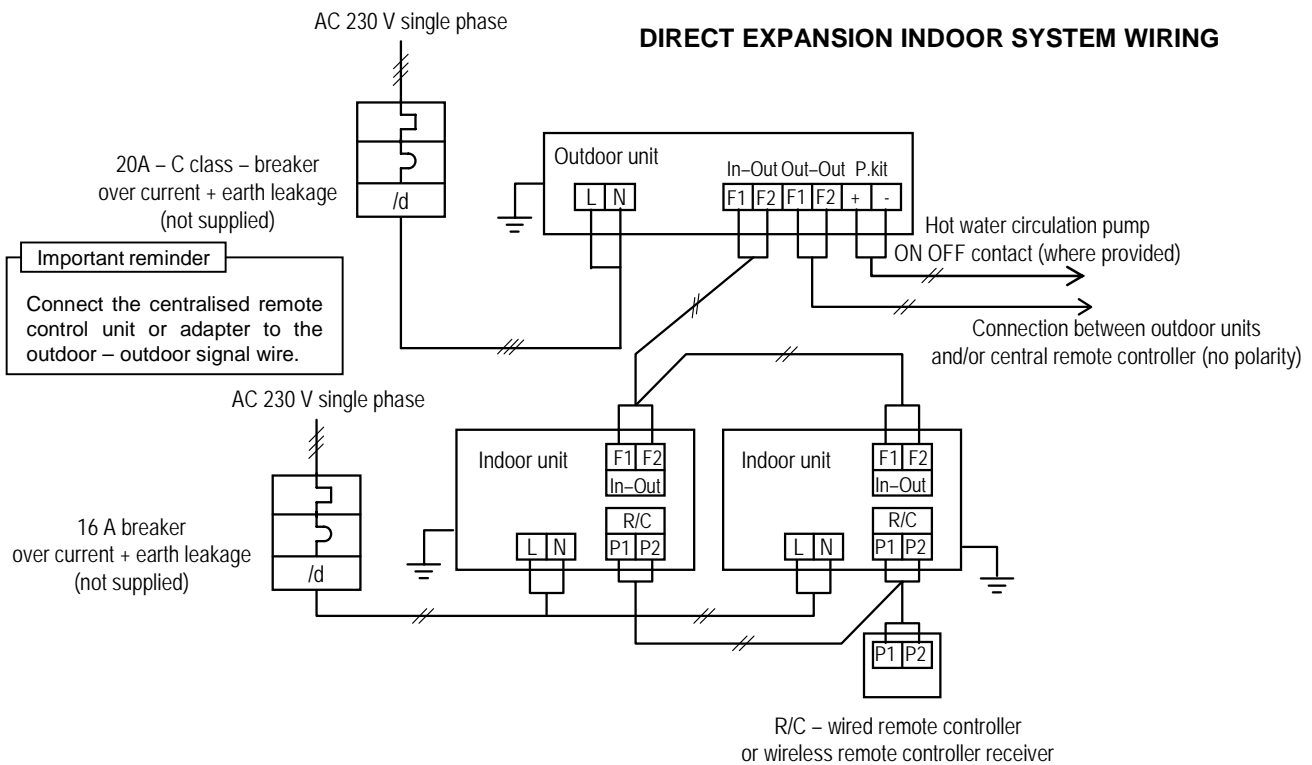

In – Out: communication line indoor unit – outdoor unit  
 Out – Out: communication line outdoor unit – outdoor unit and/or central remote controller

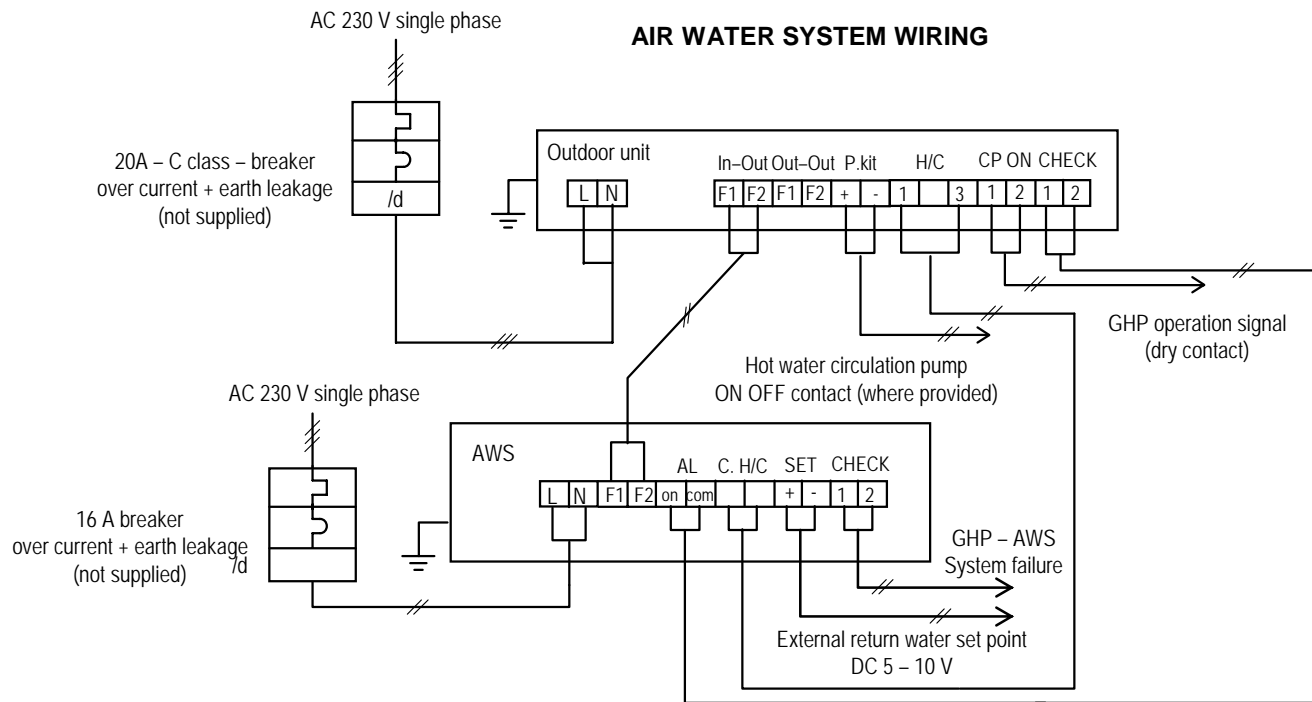



In – Out: communication line indoor unit – outdoor unit  
 Out – Out: communication line outdoor unit – outdoor unit and/or central remote controller

Electrical

## 9. Electric Wire Specifications and Precautions

### 9-1. Power supply wire

 <b>Warning</b>	
	<p>■ <b>The specifications for the electrical wiring and the selection of the appropriate size must be in accordance with the relevant local and national regulations and technical standards.</b></p> <p>Improper wiring can result in overheating, short circuit or fire.</p>

- Always install a C class circuit breaker before the GHP outdoor unit. Specifications are listed in the table below.
- Use copper conductors only.
- Use insulated wire for the power cord.
- Select the power supply cable type and size in accordance with the relevant local and national regulations and technical standards.
- Specification for local wiring are in compliance with IEC60245.
- Always ground the unit in accordance with the relevant technical standards. Use a ground wire of  $\phi$  2.0 mm or more secured to the designated grounding screw.
- Use M4 crimp terminals to connect wires to the terminal block.
- Select the power supply wire size in accordance with following table.

Power supply for one outdoor unit (Indoor unit has separate power supply)

Outdoor unit	Power supply	C class circuit breaker		Power supply wire	
		Rated current overcurrent protection	Sensitivity current earth leakage protection	Minimum thickness	Maximum line length ※
P224	Single phase 230 V AC	20 A	0,03 A	3.5 mm <sup>2</sup>	53 m (34 m)
P280					
P355					

※ Select the figure in ( ) when high static pressure mode is selected.

- The values in the upper table are reference based on Japanese regulation. Follow the relevant local and national regulations and technical standards.  
The maximum line length in the table above makes voltage drop 2%. If the length exceeds the value shown above, review the wire thickness.
- Install an over-current breaker and an electric leakage breaker to each outdoor unit in accordance with the table above and install wiring.
- The power supply wire of the indoor units must be taken from the branch circuit exclusively for the indoor units.
- Follow the wiring procedure described in the installation manual attached to the indoor units with regard to the power supply wiring, the over-current breaker, and the electric leakage breaker to be connected to the indoor units.



## 9-2. Signal wire between indoor-outdoor units and outdoor-outdoor units

### Important reminder

- **Never mix signal and power supply (230 V) wires in a multiple core cord. This will cause malfunction. In addition, provide 50 mm or more clearance between wires to prevent electrical noise influence.**

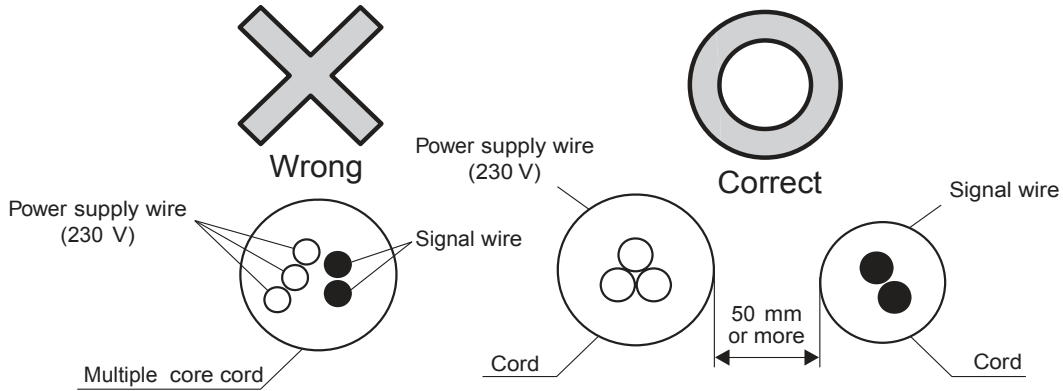

- **Always use shielded wire when installing the outdoor unit near high-frequency medical equipment, high-frequency welding equipment or any other equipment that generates high-frequency waves. Otherwise, malfunction could occur due to high-frequency waves.**
- **When using shielded wires, always ground just one side. Otherwise, communication problem could occur.**
- **Never use multiple core wires having 3 or more cores.**
- **Wire thickness must not exceed the range between 0.75 mm<sup>2</sup> to 1.25 mm<sup>2</sup>.**
- **Do not bundle signal wires.**
- **Arrange the signal wires apart from the power supply wires so that the signal wires meet the following condition to eliminate electrical noise influence.**

Capacity of power source		Isolation distance between power supply and signal wires (mm)	
		This system	Other equipment
230 V or less	10 A or less	50 mm or more *1	300 mm or more
	50 A or less		500 mm or more
	100 A or less		1000 mm or more
	Over 100 A		1500 mm or more

\* Because this system generates very little noise, isolation distance of 50 mm or more is enough.

- Signal wires between indoor-outdoor units and outdoor-outdoor units have no polarity.
- The length of the signal wires between indoor-outdoor units and outdoor-outdoor units must not exceed the following:
  - Longest wiring length: 1000 meters
  - Total wiring length: 2000 meters
- Use M3 crimp terminals to connect wires to the terminal block.
- Be sure to use vinyl sheathed wire or cable with 2 cores for signal wire in accordance with the relevant local and national regulations and technical standards.

---

### 9-3. Remote control wire

- Connect terminals of the remote control wire (P1,P2) to the indoor unit terminals (P1,P2) (P1 and P2 terminals have no polarity).

#### Wire specifications

Type of wire	Vinyl sheath code or cable
Thickness	0.75 to 1.25 mm <sup>2</sup>

- Peel the sheathed part of the wire passing through the inside of the remote controller case.

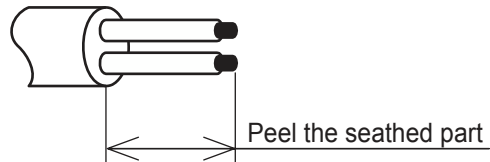

#### Important reminder

- When installing the wiring, be sure to keep signal wires away from the power supply wires so that the signal wires are not affected by electrical noise (external noise).





# 10. Power Supply Wiring Procedure

## 10-1. Wiring instruction

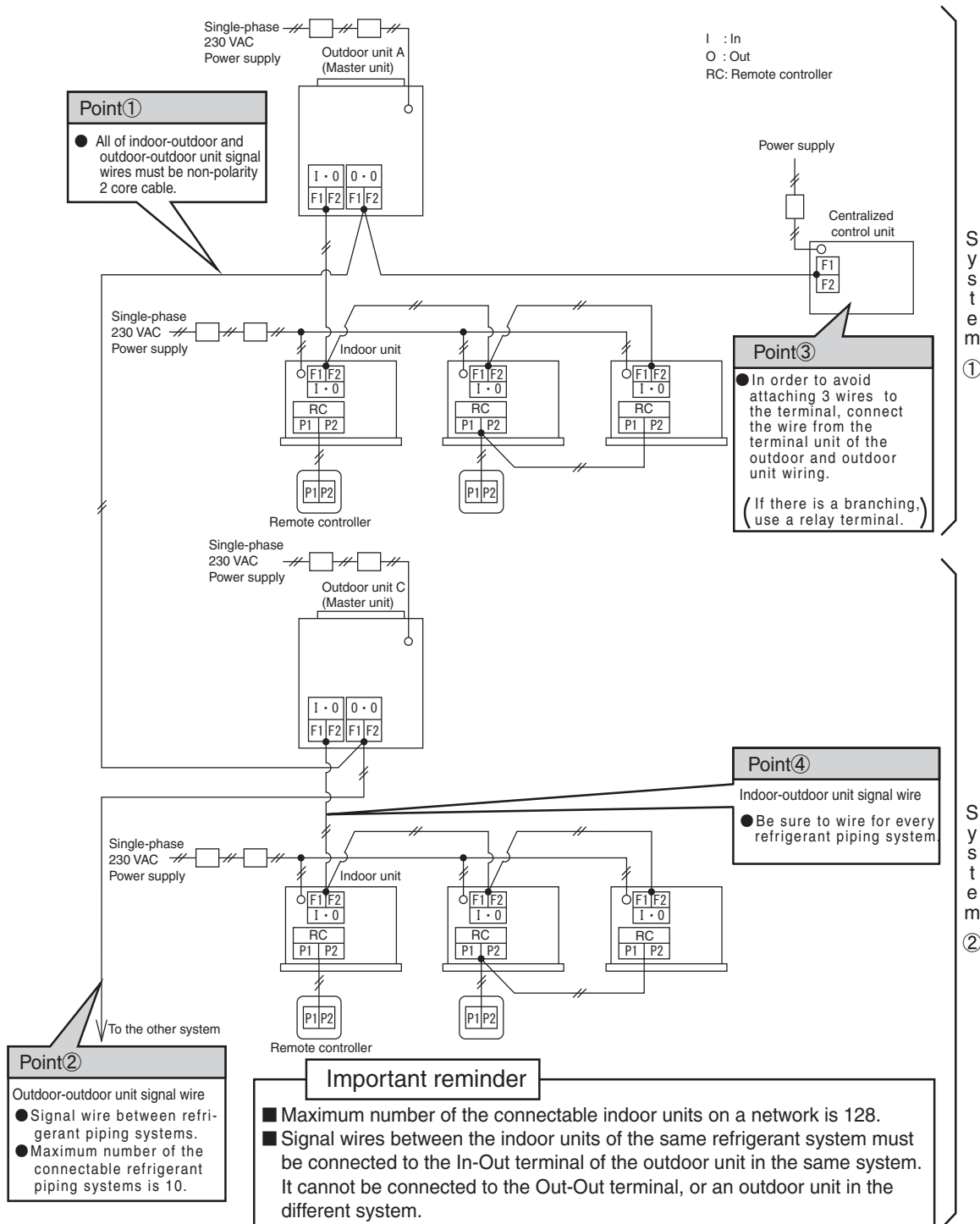

## 10-2. Wiring length

The wiring length of indoor-outdoor and outdoor-outdoor signal wires except the wiring of the remote controller must not exceed the following restriction:

- **Longest wiring length: 1000 meters**
- **Total wiring length: 2000 meters**  
(When using shielded wires, the total wire length is restricted up to 1500 meters.)

### ■ System example

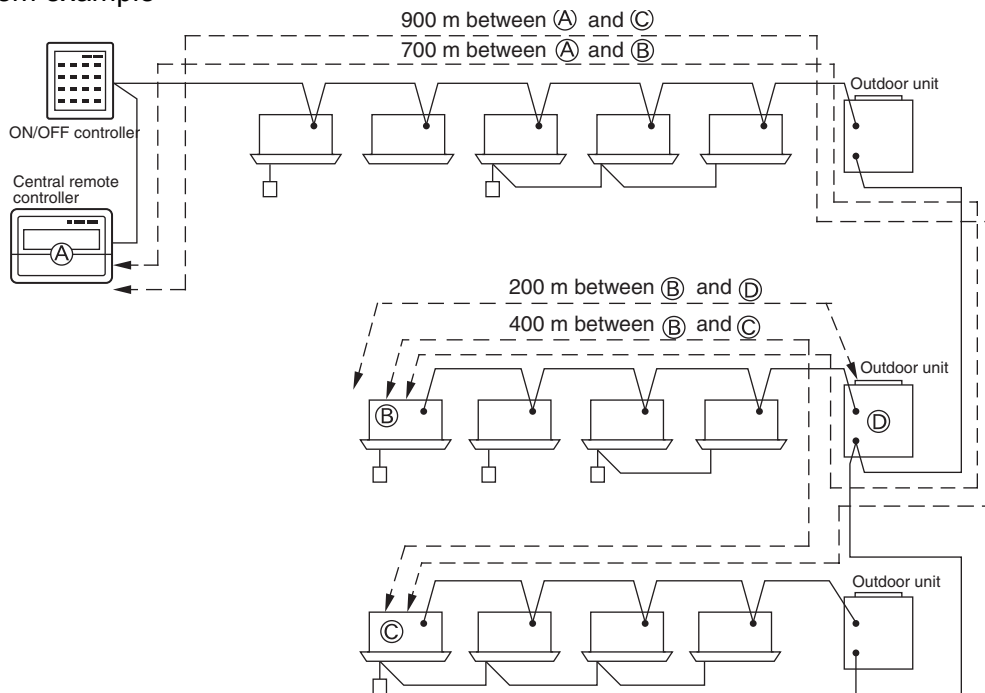

- In the above system, the longest wiring distance is 900 m between (A) and (C), which satisfies the longest wiring length limit of 1000 m. And the total length, which is the total of 900 m between (A) and (C), and 200 m between (B) and (D) is 1100 m. This also satisfies the total wiring limit of 2000 m. The system functions properly only when both the longest wiring length and the total wiring length are within the limit as shown above.

### Important reminder

- **Be sure to check the longest wiring length and the total wiring length at the time of designing. When the length exceeds the acceptable restriction range, consider dividing the system or installing a D III -NET extension adapter (sold separately) additionally.**



### 10-3. Branch wiring

The following 3 wiring methods are acceptable.

■ Series wiring

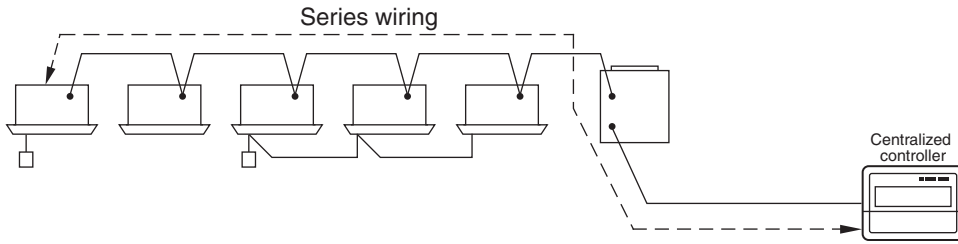

■ Bus wiring (Up to 10 branches, re-branching after the branch is not possible)

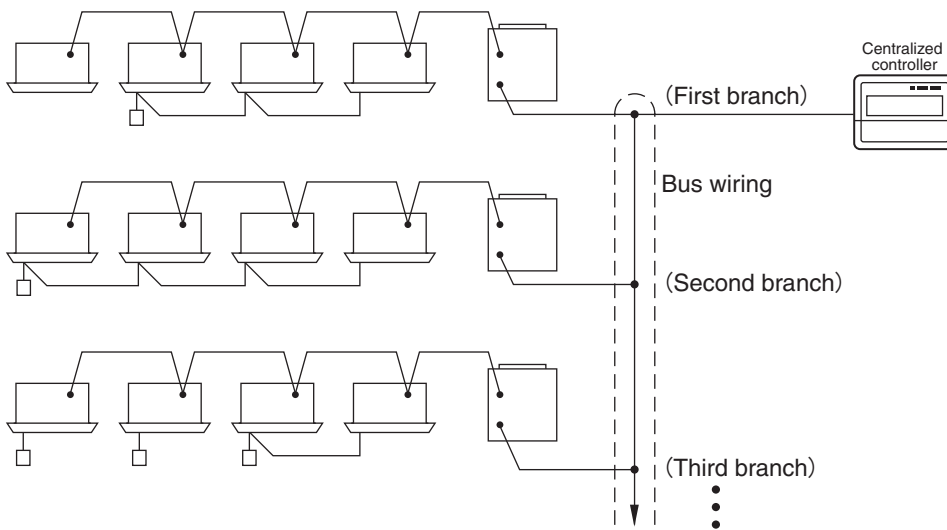

■ Star wiring (Up to 10 branches, re-branching after the branch is not possible)

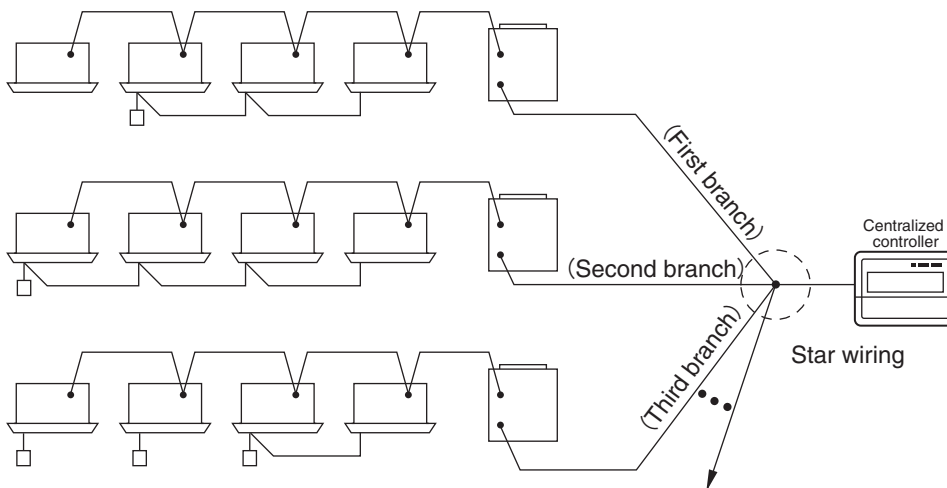

Note) Although the above figures show the examples using the centralized controller, the same wiring system can be used with other centralized control devices.

---

## 11. Various Function Settings

---

All function settings of the outdoor unit in this model are performed by board maintenance function.

### 11-1. Address setting method of the indoor and outdoor units

- The address setting of the outdoor and indoor units is performed automatically.
- When the centralised remote controller is added, set the group address to the indoor units with the standard remote controller. If the standard remote controller is not installed provide that the service centre brings a spare one to set the group address on each unit.

### 11-2. EEP dip switch setting

This model has EEP dip switches inside the outdoor unit circuit board.  
Refer to “List of EEP dip switch settings” on the following page for the contents of the switches and the factory default setting

 <b>Warning</b>	
	<ul style="list-style-type: none"><li>■ <b>Be sure to change the #4 pin of #1 EEP dip switch 1 to “ON” when the catalyser is installed.</b> If not, the protection device may operate improperly and smoke, fire or malfunction could occur.</li></ul>





 <b>Caution</b>	
	<ul style="list-style-type: none"><li>■ <b>Do not touch the moving parts (fans or belt around the engine).</b> You could be caught by the moving parts and be injured. The fans or engine may automatically start running to protect the device to maintain performance even if the GHP is stopped. Be sure to turn OFF the power breaker when you need to touch the moving parts.</li></ul>



## List of EEP dip switch settings

EEP dip switch	Pin No.	Functions	Other	Factory default							
1 Setting can be changed with check code No.80	1	Periodic inspection display	OFF: Not available / ON: Available	ON							
	2			OFF							
	3	Snow blowing function *1	OFF: Not available / ON: Available	OFF standard spec. ON Cold district spec.							
	4	Exhaust gas temperature for catalyser *2		OFF standard spec. ON catalyser spec.							
	5	Conditional silent mode		OFF							
	6	Energy saving mode		OFF							
	7	Combination Multi backup function *3	OFF: Backup starts after error reset On: Automatic backup	OFF standard spec. ON combination multi spec.							
	8			OFF							
2 Setting can be changed with check code No.81	1	Setting of cool / heat switching	OFF: Indoor unit / ON: Outdoor unit	OFF unit for DX ON unit for AWS							
	2	Master control *3	OFF	Prohibited	ON	Master collective	OFF	Dependent collective	ON	Individual setting	ON
	3		OFF		OFF		ON		ON		ON
	4										
	5										OFF
	6										OFF
	7	Outdoor fan high static pressure mode	OFF: Not available / ON: Available	OFF							
	8			OFF							
3 Setting can be changed with check code No.82	1			OFF							
	2			OFF							
	3	Reserved area *4		Depends on models							
	4	Reserved area *4		Depends on models							
	5	Reserved area *4		Depends on models							
	6			OFF							
	7			OFF							
	8			OFF							
4 Setting can be changed with check code No.83	1			OFF							
	2			OFF							
	3			OFF							
	4			OFF							
	5			OFF							
	6	Data setting status for centralized control	OFF: Not set / ON: Set	OFF							
	7			OFF							
	8	Automatic test run	OFF: Not set / ON: Set	OFF							
5 Setting can be changed with check code No.84	1			OFF							
	2			OFF							
	3			OFF							
	4			OFF							
	5			OFF							
	6			OFF							
	7			OFF							
	8			OFF							

\*1 This setting is "ON" only when the outdoor unit is cold district specification. Change this setting to "ON" in the cold district or heavy snowfall area.

\*2 This setting is "ON" only when the deodorizing catalyst is installed. Be sure to change this setting "ON" when installing the deodorizing option.

\*3 As for Combination Multi type, the setting of the master outdoor unit (outdoor unit with the outdoor-indoor communication wires connected) is reflected on this unit's operation. Only available for P450 to P710.

\*4 Do not rewrite this data.

EEP dip switch setting is set in the "check mode". Disconnect the personal computer, and then, select the check mode.





## 1) How to change the current mode to the check mode

1. Press the MODE SELECT switch. The mode LED (LED15) lights up in green.  
(Proceeding to the monitoring mode)
  2. Press and hold the SET and CLEAR switches at the same time. The mode LED (LED15) lights up in red.  
(Proceeding to the check mode)
- \* You can not proceed to the check mode within 20 seconds after turning the power on, or during system operation.
- \* You can not proceed to the check mode while the remote controller is on.

## 2) Changing EEPROM dip switch settings

1. Press the CODE No. UP or CODE No. DOWN switch to select the check code No. 80 to 84 as follows.  
(Refer to "List of EEPROM dip switch settings" on the previous page for the details about EEPROM dip switch function.)

\*oF means OFF

Code No.		Switch pin No.		on/oF status													
LED6	LED5	LED4	LED3	LED2	LED1												
<div style="display: flex; justify-content: space-around;"> <div style="text-align: center;"> <p>Display when the setting is OFF</p>   </div> <div style="text-align: center;"> <table border="1" style="border-collapse: collapse;"> <tr> <td>SW 1</td> <td>SW 2</td> <td>SW 3</td> <td>SW 4</td> <td>SW 5</td> <td>SW 6</td> </tr> <tr> <td>CODE No. UP</td> <td>CODE No. DOWN</td> <td>INDOOR SELECT</td> <td>MODE SELEC</td> <td>CLEAR</td> <td>SET</td> </tr> </table> </div> </div>						SW 1	SW 2	SW 3	SW 4	SW 5	SW 6	CODE No. UP	CODE No. DOWN	INDOOR SELECT	MODE SELEC	CLEAR	SET
SW 1	SW 2	SW 3	SW 4	SW 5	SW 6												
CODE No. UP	CODE No. DOWN	INDOOR SELECT	MODE SELEC	CLEAR	SET												
<div style="display: flex; justify-content: space-around;"> <div style="text-align: center;"> <p>Display when the setting is ON</p>   </div> <div style="text-align: center;"> <table border="1" style="border-collapse: collapse;"> <tr> <td>SW 1</td> <td>SW 2</td> <td>SW 3</td> <td>SW 4</td> <td>SW 5</td> <td>SW 6</td> </tr> <tr> <td>CODE No. UP</td> <td>CODE No. DOWN</td> <td>INDOOR SELECT</td> <td>MODE SELEC</td> <td>CLEAR</td> <td>SET</td> </tr> </table> </div> </div>						SW 1	SW 2	SW 3	SW 4	SW 5	SW 6	CODE No. UP	CODE No. DOWN	INDOOR SELECT	MODE SELEC	CLEAR	SET
SW 1	SW 2	SW 3	SW 4	SW 5	SW 6												
CODE No. UP	CODE No. DOWN	INDOOR SELECT	MODE SELEC	CLEAR	SET												

2. Select the switch pin number by pressing the INDOOR SELECT switch.  
(You can change the display as 1 → 2 → . . . → 8 → 1 each time you press the switch.)
3. Press the SET switch. LED1 and LED2 start to flash. At this time, on/oF setting can be changed by pressing the CODE No. UP or CODE No. DOWN switch.  
(Each press of either CODE No. UP or CODE No. DOWN switch changes the setting between on and oF.)
4. After selecting oF or on, press the SET switch to input the current setting. The display returns to lighting up.

\* If you press the CLEAR switch while the display is flashing, you can return the display to lighting up without inputting the current setting.

### 11-3. Gas type setting

#### Warning



- **Gas type selection must be changed by AISIN Authorised Technical Service Centre qualified personnel. Factory settings are chosen depending on the GHP version.** Failure to observe this prescription makes the warranty no longer valid.
- **If, by any chance, changing the gas type setting is necessary, please contact with the AISIN Authorised Technical Service Centre.**
- **The installation of further components may be needed when changing gas type to LPG. Please contact with the AISIN Authorised Technical Service Centre.**

Gas type setting is set in the “check mode“. Disconnect the personal computer, and then, select the check mode. To select the check mode, refer to “12-2. 1) How to change the current mode to the check mode“ on the previous page. The AISIN GHP can work with several supply gas types. Gas type can be chosen by adjusting one setting of the outdoor unit PC. In some cases it can be necessary to install a catalyser and/or replace the gas mixer.

#### 1) How to set the gas type

1. Press the CODE No. UP or CODE No. DOWN switch and select the check code No. 76 as follows.

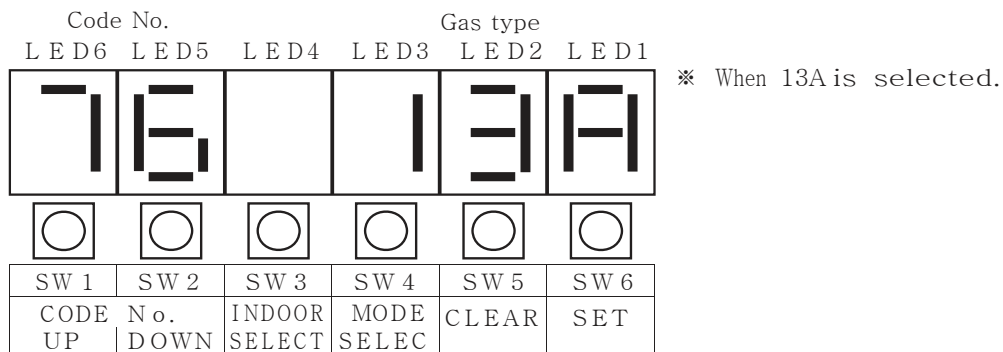

2. Press the SET switch. LED1 to LED4 start to flash. At this time, the gas type can be changed by pressing the CODE No. UP or CODE No. DOWN switch. (Refer to the following table for the details about the gas type). If you press the CLEAR switch while the display is flashing, you can go back to the previous screen without changing the gas type.

Display	Gas type
13 A	NATURAL GAS G20 (H erdgas)
12 A	NATURAL GAS G25 (L erdgas)
iPro ※	LPG (G30/G31)
H or E	Not in use

3. After selecting the gas type, press and hold the SET switch to input the current setting. The display stops blinking and the selected gas type is shown.
  4. Exit the check mode by pressing the MODE key for more than three seconds. The indoor unit recognition procedure starts back.
- ※ Propane – Butane mixtures are allowed up to 70% Propane and 30% Butane. Other mixtures, outside the indicated range, are not allowed.

#### Installation of the external gas regulator

Whereas the supply gas pressure was higher than the prescribed one, indicated on the AISIN GHP plate, or anyway LPG (G30/G31) is used as supply gas, install an external gas regulator, such as the one described in the figure.

(eg. Madas model RG/2MTA DN 20 20 – 60 mbar or similar, CE marked, EN88 compliant).

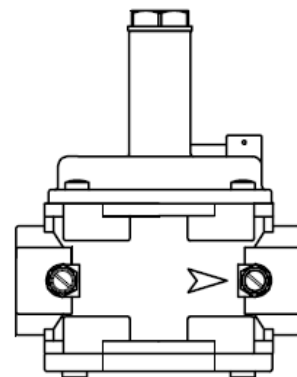

## 11-4. Field settings with the remote controller





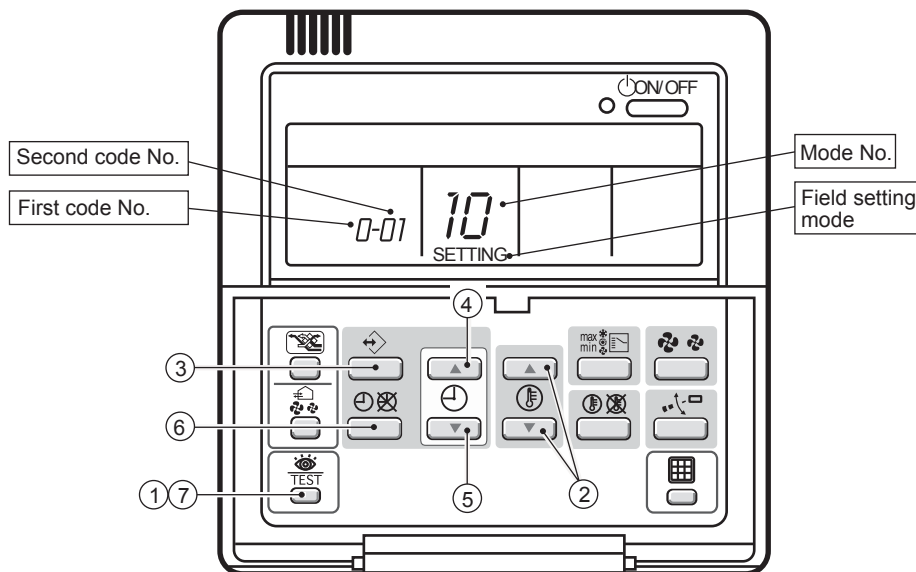

### ■ Master control setting

- What is master control?  
Only master remote controller can select “cooling”, “heating”, and “dry”.
- How to set master control  
A remote controller you press the “OPERATION CHANGE / MIN-MAX” button first after installation of the indoor / outdoor unit is the master controller.
- How to change the master controller  
To change the master controller, refer to “SETTING THE MASTER REMOTE CONTROLLER” in the operation manual attached to the indoor unit.

### ■ Field setting



#### Setting procedure

1. In the normal mode, press the  button for 4 seconds or longer. The mode changes to the “field setting mode”.
2. Press the  button and select the “mode number” to set.
3. When setting each indoor unit under group control (when selecting 20, 22, 23 and 25 mode numbers), press the  button and select the “indoor unit number” to set. (This step is not required at the time of group setting.)
4. Press the  up button to select “First code number”.
5. Press the  down button to select “Second code number”.
6. To input current setting changes, press  button once.
7. Press the  button for about 1 second. The mode returns to the “normal mode”.

(Example) To set the filter sign display interval to “Filter contamination-Heavy” at the time of group setting, select the mode number “10”, first code number “0” and second code number “02”.



## 11-5. List of setting contents and mode numbers

	Mode No. *1	First code No.	Description of contents		Second code No. *2					
					01	02	03	04		
Setting at indoor unit side	10(20)	0	Filter contamination - Heavy/Light (Setting of filter sign display interval for cleaning) (Setting to reduce displaying period to half when filter contamination is heavy.)	Ultra-long-life type	Light	Approx. 10,000 H	Heavy	Approx. 5,000 H	—	—
				Long-life type		Approx. 2,500 H		Approx. 1,250 H		
				Standard type		Approx. 200 H		Approx. 100 H		
			1	Long-life filter type (Setting of filter sign display interval for cleaning) (Change setting when ultra-long filter is installed)		Standard (long-life filter)	Ultra-long life filter	—	Oil guard filter	
			2	Thermostat sensor in remote controller *3		Use both the unit sensor (or remote sensor if installed) AND the remote controller sensor. *5+6	Use unit sensor only (or remote sensor if installed). *5+6	Use remote con- troller sensor only. *5+6	—	
			3	Display of air filter cleaning sign (To be set when not setting filter cleaning sign)		Display	Not display	—	—	
			5	Information to I-manager, I-touch controller		Only unit sensor value (or remote sensor value if installed).	Sensor value as set by 10-2-0X or 10-6-0X.	—	—	
		6	Thermostat sensor in group control		Use unit sensor only (or remote sensor if installed). *6	Use both the unit sensor (or remote sensor if installed) AND the remote controller sensor. *4, 5, 6	—	—		
		12(22)	0	Output signal X1-X2 of the optional adopter; KRP1B PCB unit		Indoor unit thermo-ON + compressor run	—	Operation	Malfunction	
			1	ON/OFF input from outside (T1/T2 input) (Setting for when forced ON/OFF is to be operated from outside).		Forced OFF	ON/OFF operation	—	—	
			2	Thermostat differential changeover (To be set when using remote sensor)		1 °C	0.5 °C	—	—	
			3	Fan setting during thermostat OFF at heating operation (For capacity increase of air cleaning unit)		LL	Set speed	OFF*7	—	
			4	Differential automatic changeover		0 °C	1 °C	2 °C	3 °C *8	
			5	Automatic re-start after power failure (Return to the status before the blackout)		Disabled	Enabled	—	—	
		13(23)	0	Setting for ceiling height (for AXAP model; setting for air flow rate) *9		Standard	High ceiling 1	High ceiling 2	—	
			1	Selection of air flow direction (To be set when installing a blocking pad kid)		4-way flow	3-way flow	2-way flow	—	
			3	Air flow direction selecting function (To be set when attaching decorative panel to air outlet)		Equipped	Not equipped	—	—	
			4	Air flow direction range setting		Upper	Normal	Lower	—	
			5	Setting of fan speed (Control with the air outlet at the time of phase control)		Standard	Option 1	Option 2	—	
		15(25)	3	Drain pump operation with humidifying		Not equipped	Equipped	—	—	

	Mode No. *1	First code No.	Description of contents	Second code No. *2			
				01	02	03	04
	1b	0	Permission level setting	Level 2	Level 3	—	—
		1	Leave home function	Not permitted	Permitted	—	—
		2	Thermostat sensor in remote controller (For limit operation and leave home function only)	Use	Not use	—	—

- \*1 Each mode setup is programmed in the group mode. When setting individually by each indoor unit, select the mode number in ( ) in the table.  
However, the current setting status only can be confirmed individually by selecting the number in ( ). In a group setting, even though all of the second code numbers are selectable, a display on the LCD remains in 01.
- \*2 The second code number settings at the factory depend on indoor unit types. For more details, refer to the installation and operation manual attached to each indoor unit.
- \*3 When the remote controller cannot be installed in a living space, thermostat sensor in the remote controller must be set to “Not use (10-2-02)”.
- \*4 If group control is selected and the remote controller sensor is used, then set 10-6-02 & 10-2-03.
- \*5 If setting 10-6-02+10-2-01 or 10-2-02 or 10-2-03 are set at the same time, then setting 10-2-01, 10-2-02 or 10-2-03 have priority.
- \*6 If setting 10-6-01+10-2-01 or 10-2-02 or 10-2-03 are set at the same time for group connection, 10-6-01 has priority and for individual connection, 10-2-01, 10-2-02 or 10-2-03 have priority.
- \*7 Only use in combination with optional remote sensor or when setting 10-2-03 is used.
- \*8 More settings are: Second code No.; 05 / 4 °C , 06 / 5 °C , 07 / 6 °C , 08 / 7 °C .
- \*9 Refer to the following chart “Rough guide of a setup for high ceiling application” for more details.
- \* Do not make any settings not given in the table.
- \* Not displayed if the indoor unit is not equipped with that function.
- \* When returning to the normal mode, “88” may be displayed in the LCD in order for the remote controller to initialize itself.
- \* Depending on an operation status, setting of fan speed may be different from actual fan speed.
- \* It is not possible to change field settings on the remote controller that is set to “sub”.

■ Rough guide of a setup for high ceiling application (AXFP/AXHP/AXAP only)

		Ceiling embedded round flow cassette type								Ceiling suspended type (P36 ~ 112)	Wall mounted type	Second code No. setting
		P28 ~ P80				P90 ~ P140						
		All-round blow	4-way *1 blow	3-way blow	2-way blow	All-round blow	4-way *1 blow	3-way blow	2-way blow			
Ceiling height	Standard	2.7 m or less	3.1 m or less	3.0 m or less	3.5 m or less	3.2 m or less	3.4 m or less	3.6 m or less	4.2 m or less	2.7 m or less	Standard air flow rate	01
	High ceiling 1	3.0 m or less	3.4 m or less	3.3 m or less	3.8 m or less	3.6 m or less	3.9 m or less	4.0 m or less	4.2 m or less	2.7 ~ 3.5 m	A little increased air flow rate	02
	High ceiling 2	3.5 m or less	4.0 m or less	3.5 m or less	—	4.2 m or less	4.6 m or less	4.2 m or less	—	—	Increased air flow rate	03

- \*1 When you change all-round blow to 4-way blow, the blocking pad kit is required separately to block the corner portions

## 12. Remote Control

### 12-1. Remote control with 2 remote controllers

- 1 indoor unit control with 2 remote controllers at 2 locations

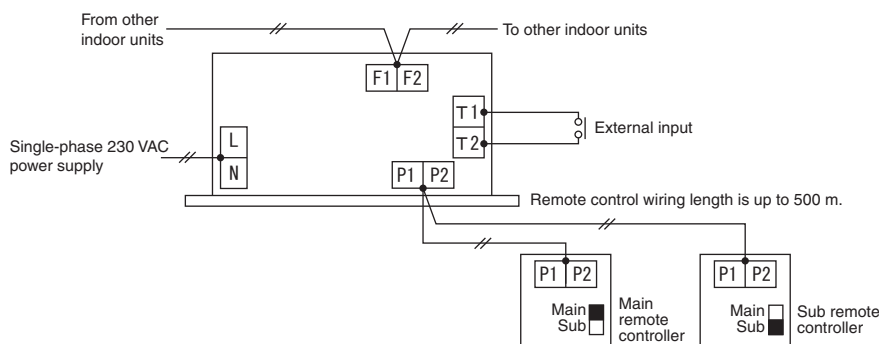

Note)

If the main and sub remote controllers equipped with thermostat sensors are mounted in separate rooms, set the main remote controller thermostat to "Not use" when performing field setting with the remote controller.

- A later command by either of the remote controllers can override the previous command by either one to control the indoor unit operation.
- Only the thermostat in the main remote controller is recognized by the indoor unit when installing 2 remote controllers.
- To set the remote controllers to main or sub, remove the front panels of the remote controllers and set the main/sub changeover switches on the PC boards to "Main" or "Sub". "Field settings with the remote controller" can set only the main remote controller.

### 12-2. Group control

- Simultaneous control of up to 16 units with 1 remote controller

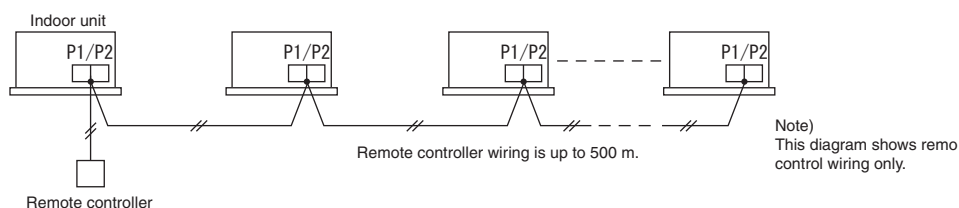

- Because remote control wiring for group control has no polarity, P1 and P2 can be switched.
- All indoor units within the group have the same setting, and each indoor unit is controlled individually by its own built-in thermostat.
- At the time of group control, remote controller thermostat is set to "Not use" automatically.
- Because the address is set automatically, address setting by the remote controller for group control is not necessary.

---

## 13. Test Operation

---

In the explanation of test operation, the model that is not the subject of this manual (Combination Multi) is also described.

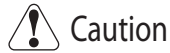

■ **Do not touch the moving parts.**

You could be injured.

The fans or engine may automatically start running to protect the device to maintain performance even if the GHP is stopped.

Be sure to turn OFF the power breaker when you need to touch the moving parts.

### 13-1. Before starting test operation

1. Turn ON the main power supply and the electric leakage breaker inside the outdoor unit's control box at least 6 hours before the test operation to energize the compressor heater.
2. Be sure to fully open the stop valves of the outdoor unit for both liquid and vapor pipes. (Open the liquid stop valve first, and then open the vapor stop valve.)
3. Open the fuel gas valve.

### 13-2. Process of the outdoor unit when turning on the power

At the time of initial power supply, the system will first perform power master setting and address setting (outdoor and indoor address). Therefore, wait for up to 15 minutes until the unit starts operation.

Be sure to perform test operation after turning on the power when you turn on the power at the first time.

The following shows the procedure from turning on the power to completion of connection check.

### 1) Model information display

After turning on the power, the model information is displayed for about 10 seconds (shown below) and after that, it proceeds to "2) Connection check."

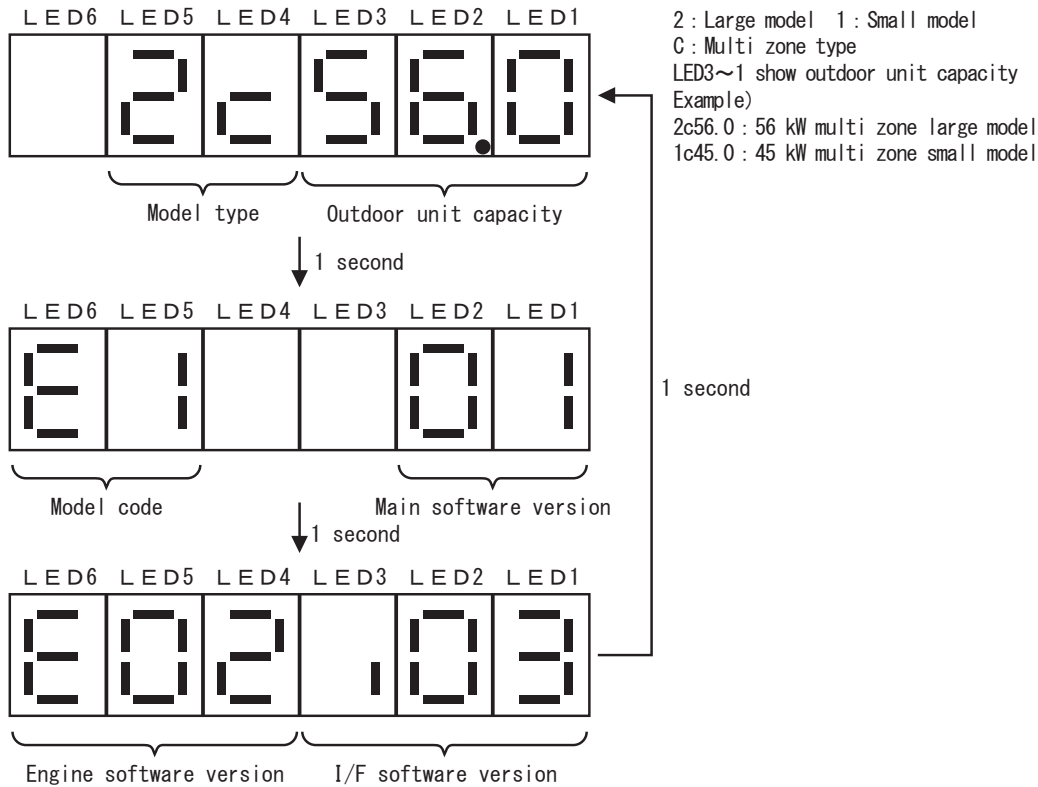

### 2) Connection check

This step checks indoor and outdoor unit connection condition. Display during the connection check is as follows:

P : Master unit C : Dependent unit  
— : Unconfirmed whether master or dependent  
(Lights up when memorized, flashes when not memorized)

A 0 : Checking indoor unit connection  
A 1 : Checking outdoor unit  
(Combination Multi) connection

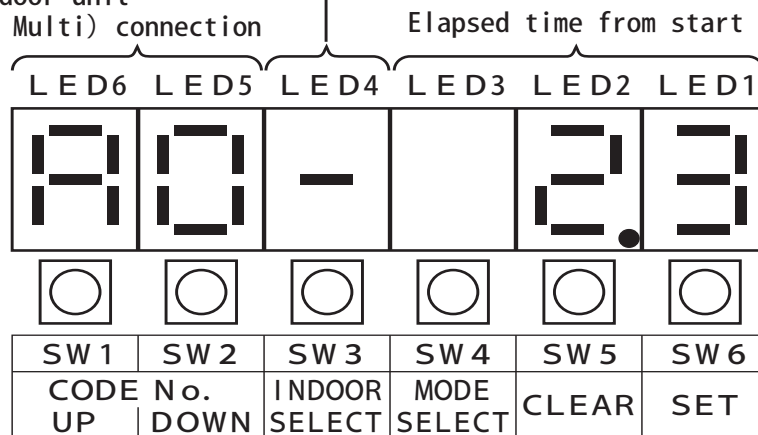

When connection check is finished, it proceeds to the following step automatically.

- If the connection condition is not memorized, it proceeds to "3) Connection condition check."
- If the connection status is memorized, it proceeds to "4) Connection condition display."  
(When re-wiring recognition is performed, connection condition is not memorized.)

\* It takes about 6 to 15 minutes until connection check is finished.

### 3) Connection condition check

Check if the wiring between outdoor and indoor units is connected correctly with the display indicated on the master and dependent outdoor units.  
The display is as follows.

- In the case of Combination Multi master unit, or single outdoor unit

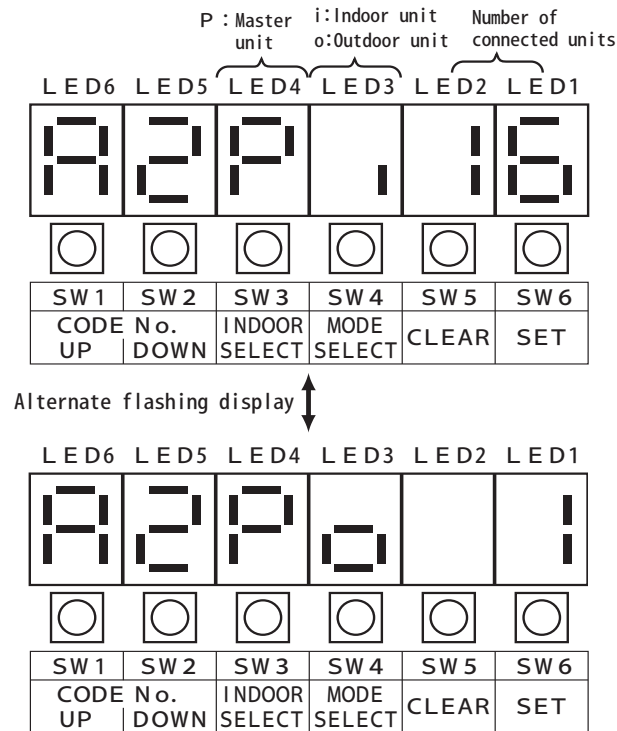

- In the case of Combination Multi dependent unit

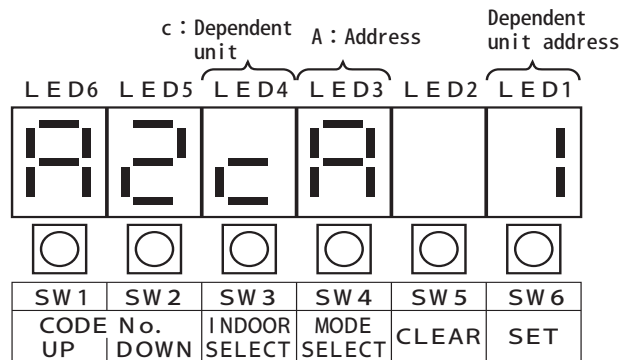

Check both the master and dependent unit displays, and make sure that the number of connected indoor and outdoor units and the dependent unit address are properly displayed.

If the connection condition display agrees with the actual condition, press SET switch on the master unit for 2 seconds or longer to fix the connection condition. (Current connection condition is memorized.)

After fixing the connection status, the display automatically proceeds to "4) Connection condition display."

When the connection condition is not correct, turn off the power supply and check the wiring, and then turn the power supply on again.

The dependent unit proceeds automatically to "4) Connection status display" when the master unit memorizes the connection condition information.

#### 4) Connection condition display

Connection condition is displayed (shown below) for about 10 seconds. After that, the display automatically changes to normal operation mode (running hour display).

■ In the case of Combination Multi master unit, or single outdoor unit

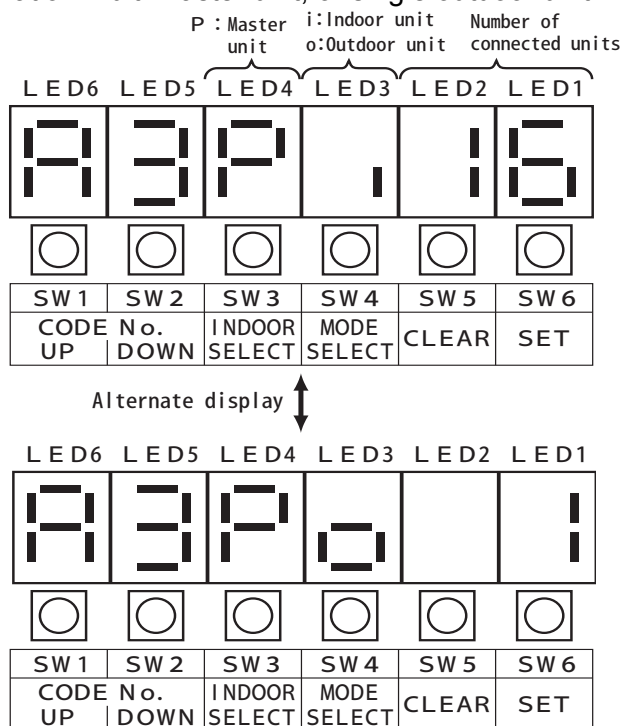

■ In the case of Combination Multi dependent unit

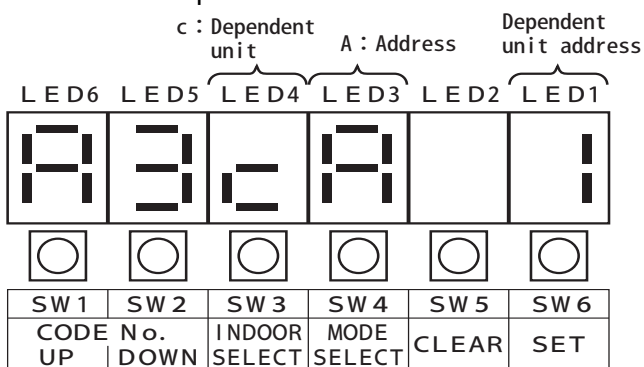

After Installation

### 13-3. When installing additional indoor / outdoor units or replacing the indoor / outdoor unit PCB

- When changing the number or indoor units or replacing the indoor unit PCB

Perform re-wiring recognition of the indoor units.

- When changing the number of outdoor units or replacing the outdoor unit PCB

Perform re-wiring recognition of the outdoor units.

- Indoor / outdoor unit re-wiring recognition process

Indoor / outdoor unit re-wiring recognition is performed in the “check mode”. Disconnect the personal computer, and select the check mode.

To select the check mode, refer to “12-2. 1) How to change the current mode to the check mode” on page 47.

1. Press the CODE No. UP or CODE No. DOWN switch and select the check code No. 01 as indicated in the following figure.

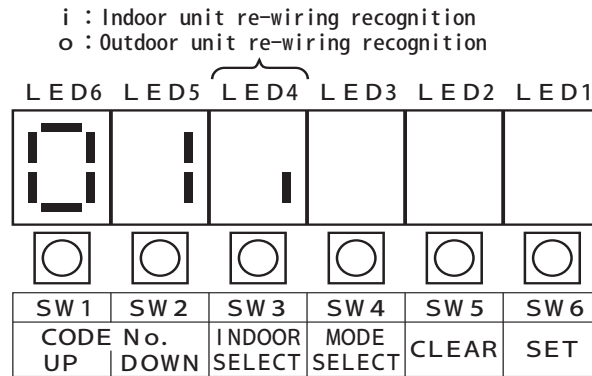

2. Press the INDOOR SELECT switch and select “Indoor unit re-wiring recognition” (indicated with i) and “Outdoor unit re-wiring recognition” (indicated with o).

3. Press and hold the SET switch. The following display is shown.

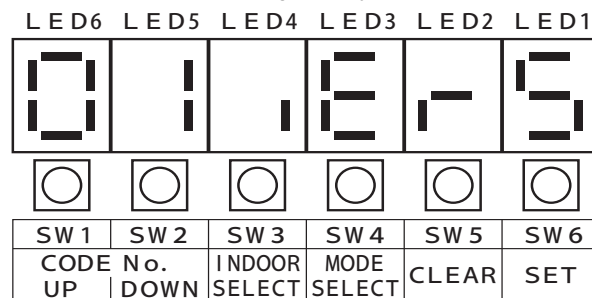



4. Press the SET switch again for 2 seconds or longer while the above-mentioned display (step 3) is shown. Selected re-wiring is recognized and the display is as follows:

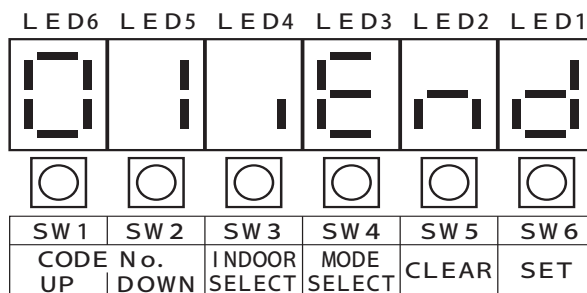

After completing re-wiring recognition, the system returns to “14-2. 2) Connection check”, and checks the connection condition again.

# 14. Installation Check List

Installation	Outdoor unit	<input type="checkbox"/> Are there any problems with the exterior and interior of the outdoor unit? <input type="checkbox"/> Is there any possibility that a short circuit operation could occur due to outdoor unit exhaust heat? <input type="checkbox"/> Is there specified space for air flow and servicing? <input type="checkbox"/> Is there any possibility that discharged air from the outdoor unit or engine exhaust gas accumulates inside the room or flows into the room? <input type="checkbox"/> Is there proper drainage from the outdoor unit? <input type="checkbox"/> Is there any possibility that the exhaust gas from the outdoor unit blows directly toward the plants or animals.?
	Indoor unit	<input type="checkbox"/> Are there any problems with the exterior and interior of the indoor unit? <input type="checkbox"/> Is the downward gradient for drain pipe 1/100 or more? <input type="checkbox"/> Is there specified space for air flow and servicing? <input type="checkbox"/> Is centering of the pulley or belt tension of the indoor unit appropriate? (If the indoor unit uses fan belts.)
Refrigerant piping installation		<input type="checkbox"/> Is the number of connected indoor units within the limit? <input type="checkbox"/> Is the total capacity for the connected indoor units within the limit? <input type="checkbox"/> Are the lengths and differences in height of the refrigerant piping within the permissible ranges? <input type="checkbox"/> Are the branch pipes properly installed? <input type="checkbox"/> Is the piping properly insulated? <input type="checkbox"/> Has the proper amount of additional refrigerant been added? <input type="checkbox"/> Have you written down the installation record and refrigerant amount on the "POINTS FOR INSTALLATION" plate with a permanent marker?
Drain piping installation		<input type="checkbox"/> Have you installed the exhaust drain piping in accordance with the specifications? <input type="checkbox"/> Do the outdoor unit exhaust drain and indoor unit drain flow into the separate receptacles? <input type="checkbox"/> Have you checked that the drain water drains properly through the drain piping? <input type="checkbox"/> Is the drain piping properly insulated?
Gas piping		<input type="checkbox"/> Are there any fuel gas leaks? <input type="checkbox"/> Does the type of gas supplied match the type indicated on the name plate?
Electric wiring installation		<input type="checkbox"/> Are the power supply wire and signal wires connected properly? <input type="checkbox"/> Is the outdoor unit properly grounded? <input type="checkbox"/> Are 2-core cables used for the signal wire instead of multi-core cables? <input type="checkbox"/> Is the wiring length within the permissible range? Is the wire thickness proper?
Options		<p><b>[Check the following items additionally if the outdoor unit is installed in the cold district or heavy snow-fall area.]</b></p> <input type="checkbox"/> Has the snow hood been mounted? <input type="checkbox"/> Has the drain heater been installed? <input type="checkbox"/> Does the heated drain hose overlap the drain water outlet as specified? <input type="checkbox"/> Is the hose clip installed?
		<p><b>[Check the following item as well if the vibration of the outdoor unit can cause problems]</b></p> <input type="checkbox"/> Has the antivibration mount been installed?

# (Reference) Troubleshooting

Perform inspections in accordance with the error displays on the remote controller and the outdoor unit circuit board.

## 1. Error code display

Remote controller error code	Outdoor unit error code	Description of breakdown
A0	63 - n	● Indoor unit: External protective device activation
A1	20 - n	● Indoor unit: Circuit board failure, EEPROM setting error
A3	95 - n	● Indoor unit: Drain water level system malfunction
A6	15 - n	● Indoor unit: Locked fan
A7	35 - n	● Indoor unit: Swing flap motor failure
A8	25 - n	● Indoor unit: Abnormal power supply voltage
A9	21 - n	● Indoor unit: Electronic expansion valve driving unit failure
AF	30 - n	● Indoor unit: Drainage failure
AH	31 - n	● Indoor unit: Dust collector failure
AJ	22 - n	● Indoor unit: Capacity setting error
C1	27 - n	● Indoor unit: Transmission failure (indoor circuit board - fan circuit board)
C4	18 - n	● Indoor unit: Heat exchanger liquid pipe temperature sensor failure
C5	19 - n	● Indoor unit: Heat exchanger vapor pipe temperature sensor failure
C6	26 - n	● Indoor unit: Combination failure (indoor circuit board - fan circuit board)
C9	97 - n	● Indoor unit: Intake air temperature sensor failure
CA	98 - n	● Indoor unit: Discharge air temperature sensor failure
CJ	17 - n	● Remote controller sensor failure
U0	88 - 5	● Refrigerant empty
U4	—	● Transmission error between indoor unit and outdoor unit
U5	1 - n	● Transmission failure between remote controller and indoor unit
—	3 - 0	● Transmission failure between indoor unit and outdoor units
U7	4 - 0	● Communication failure between outdoor units 1
	4 - 1	● Communication failure between outdoor units 2
	4 - 2	● Communication failure between outdoor units 3
	4 - 3	● Communication failure between outdoor units 4
	4 - 4	● Communication failure between outdoor units 5
	4 - 5	● Communication failure between outdoor units 6
	4 - 6	● Communication failure between outdoor units 7
—	5 - n	● Transmission failure between indoor unit and outdoor units
U8	—	● Transmission failure between main and sub remote controllers
U9	—	● Failure of other indoor units
UA	43 - 1	● Excessive connection of indoor units
	44 - n	● Indoor unit circuit board type setting failure, incorrect indoor and outdoor units combination
UC	36 - n	● Centralized control address duplication
		● Air net address duplication
UE	23 - n	● Transmission failure between indoor unit and centralized remote controller
UF	24 - n	● Refrigerant system is not set, improper wiring
UH	—	● System failure

\* “n” of outdoor unit error code ??-n indicates the indoor unit air-net address.

\* RC error code A7, AF, AH, CJ and UC indicate minor errors not stopping operation (Alert or Warning).

\* Outdoor unit error code is displayed only while pressing the CODE No. UP switch on the maintenance board when the system has an error.

Remote controller error code	Outdoor unit error code	Description of breakdown
E1	40 - 0	● Outdoor unit EEPROM failure
	40 - 1	● Outdoor unit model code failure
	40 - 2	● Outdoor unit programs do not match between main microcomputer and engine microcomputer
	84 - 3	● Outdoor unit communication failure between main microcomputer and engine microcomputer
	84 - 4	● Outdoor unit communication failure between main microcomputer and I/F microcomputer
E3	86 - 0	● Refrigerant high pressure failure 1
	86 - 1	● Refrigerant high pressure failure 2
E4	88 - 0	● Refrigerant low pressure failure
E7	86 - 11	● Outdoor heat exchanger fan 1 starting failure
	86 - 12	● Outdoor heat exchanger fan 2 starting failure
	86 - 21	● Outdoor heat exchanger fan 1 abnormal speed
	86 - 22	● Outdoor heat exchanger fan 2 abnormal speed
E7	86 - 10	● All outdoor heat exchanger fans failure
EA	57 - 0	● 4-way changeover valve switching failure
EC	80 - 0	● Overheated engine coolant
	80 - 3	● Overcooled engine coolant
EH	80 - 10	● Engine coolant pump starting failure
	80 - 20	● Engine coolant pump speed failure
	80 - 30	● IPM failure
F3	91 - 0	● Excessive compressor discharge pipe temperature
F4	87 - 0	● Excessive compressor intake temperature
	87 - 2	● Insufficient degree of superheat for compressor intake
FE	81 - 0	● Abnormal engine oil pressure
	81 - 10	● Engine oil leakage
FF	58 - 0	● Inadequate refrigerant oil
FJ	47 - 0	● Abnormal engine exhaust air temperature when deodorizing option is installed
H3	76 - 0	● Disconnected refrigerant high pressure switch
	76 - 10	
H9	61 - 0	● Disconnected outside air temperature sensor
	61 - 1	● Short-circuited outside air temperature sensor
HC	70 - 0	● Disconnected engine coolant temperature sensor
	80 - 1	● Short-circuited engine coolant temperature sensor
HJ	80 - 2	● Engine coolant empty
HF	EE - 0	● Outdoor unit periodic inspection
J3	78 - 0	● Disconnected compressor discharge pipe temperature sensor 1
	78 - 1	● Disconnected compressor discharge pipe temperature sensor 2 (450 / 560 / 710 types only)
	91 - 2	● Short-circuited compressor discharge pipe temperature sensor 1
	91 - 3	● Short-circuited compressor discharge pipe temperature sensor 2 (450 / 560 / 710 types only)
J4	55 - 0	● Disconnected accumulator outlet temperature sensor
	55 - 2	● Short-circuited accumulator outlet temperature sensor
J5	53 - 0	● Disconnected compressor intake temperature sensor
	53 - 2	● Short-circuited compressor intake temperature sensor

\* "n" of outdoor unit error code ??-n indicates the indoor unit air-net address.

\* RC error code E7 and HF indicate minor errors not stopping operation (Alert or Warning).

\* Outdoor unit error code is displayed only while pressing the CODE No. UP switch on the maintenance board when the system has an error.

Remote controller error code	Outdoor unit error code	Description of breakdown
J6	65 - 0	● Disconnected outdoor heat exchanger liquid temperature sensor
	65 - 2	● Short-circuited outdoor heat exchanger liquid temperature sensor
	85 - 0	● Disconnected outdoor heat exchanger vapor temperature sensor
	85 - 2	● Short-circuited outdoor heat exchanger vapor temperature sensor
J7	66 - 0	● Disconnected sub heat exchanger liquid temperature sensor
	66 - 1	● Short-circuited sub heat exchanger liquid temperature sensor
J8	67 - 0	● Disconnected outdoor liquid pipe temperature sensor
	67 - 2	● Short-circuited outdoor liquid pipe temperature sensor
JA	73 - 0	● Refrigerant high pressure sensor 1 failure 1
	73 - 1	● Refrigerant high pressure sensor 1 failure 2
	73 - 2	● Refrigerant high pressure sensor 2 failure 1
	73 - 3	● Refrigerant high pressure sensor 2 failure 2
JC	88 - 4	● Refrigerant low pressure sensor failure
JE	71 - 0	● Disconnected engine oil pressure switch
JJ	72 - 0	● Disconnected engine compartment temperature sensor
	72 - 1	● Short-circuited engine compartment temperature sensor
	72 - 6	● Disconnected engine exhaust air temperature sensor when deodorizing option is installed
LE	75 - 1	● Igniter undervoltage
	75 - 2	● Igniter disconnection
	75 - 3	● Igniter overvoltage
	75 - 10	● Starter transformer voltage cut off
LF	84 - 0	● Engine starting failure
LH	68 - 10	● Generating converter minor malfunction
	68 - 20	● Generating converter major malfunction
LJ	75 - 0	● Engine stop
P8	74 - 1	● Insufficient engine starting speed
	74 - 4	● Engine speed control failure
	82 - 0	● Engine overspeed failure 1
	82 - 1	● Engine overspeed failure 2
PE	74 - 7	● Output failure of electromagnetic gas valve
PF	60 - 0	● Unintended starter operation

\* "n" of outdoor unit error code ??-n indicates the indoor unit air-net address.

\* Outdoor unit error code is displayed only while pressing CODE No. UP switch on the maintenance board when the system has an error.

## 2. Cancelling the error codes

- After repairing the troubled part, press the ON/OFF button of the remote controller. The error code display disappears and operation condition turns into "STOP".
- Operation restarts by pressing the ON/OFF button of the remote controller again.

## (Reference) GHP specifications

Standard Model			AXGP224E1-(F)WED- -	AXGP280E1-(F)WED- -	AXGP355E1-(F)WED- -	
Renewal Model			AXYGP224E1-(F)WED- -	AXYGP280E1-(F)WED- -	AXYGP355E1-(F)WED- -	
Rated Output			8 HP	10 HP	13 HP	
Rated cooling capacity *			kW	22,4	28,0	35,5
Rated heating capacity **			kW	25,0	31,5	40,0
Maximum heating capacity			kW	26,5	33,5	42,5
Electrical features	Power supply		V	AC 230 single phase		
	Starting current		A	20		
	Power consumption	Cooling	kW	0,34	0,44	0,57
		Heating		0,42	0,58	0,74
	Running current	Cooling	A	1,3	1,7	2,1
Heating		1,6		2,1	2,6	
Fuel gas	Consumption (NG – LPG)	Cooling	kW	15,0	19,2	26,4
		Heating		15,9	20,3	27,0
		Maximum flow		22,2	27,8	36,2
	Supply pressure	<b>Category</b>		<b>Country</b>		<b>Test Pressure</b>
		I12H3+		IT – GB – IE – ES – GR – PT		G20-20 mbar G30/G31-30/37 mbar
		I12H3B/P		DK – FI – SE – NO – SI – SK CZ – EE – LV – LT – LU		G20-20 mbar G30/G31-30 mbar
		I12H3B/P		HU		G20-25 mbar G30/G31-30 mbar
		I12ER3+		FR		G20/G25-20/25 mbar G30/G31-28/30 mbar
		I12L3B/P		NL		G25-25 mbar G30/G31-30 mbar
		I2E		DE		G20-20 mbar
I2H		AT		G20-20 mbar		
I2H		CH		G20-20 mbar		
I2ER(B)		BE		G20/G25-20/25 mbar		
I3+		BE		G30/G31-28/30 mbar		
I3B/P		CY		G30/G31-30 mbar		
I3B/P		MT		G31-30mbar		
Engine	Type		Water cooled vertical type, 4 cycle, 3 cylinder			
	Displacement		cm <sup>3</sup>	952		
	Rated output		kW	5,0	6,2	7,9
	Revolution range	Cooling	rpm	800~1.250	800~1.550	800~2.000
		Heating		800~2.450	800~2.900	800~2.900
Lubricant	Type		AISIN GHP OIL L10.000 G <b>(refill every 10.000 hours, replace every 30.000 hours)</b>			
	Quantity		lt.			
Engine coolant	Type		AISIN Coolant S			
	Quantity		lt.			
	Concentration (standard / cold district)		%			
			50 / 65			
Compressor	Type x number of units		Scroll X 1			
	Specified refrigeration oil		NL 10			
	Quantity		lt.			
	Revolution range	Cooling	rpm	1.640~2.563	1.640~3.178	1.640~4.100
		Heating		1.640~5.023	1.640~5.945	1.640~5.945
Transmission		Poli V belt				
Refrigerant	Type		R410A			
	Quantity		kg			
Fan (2 x propeller fan)		Total flow rate	m <sup>3</sup> / min	167	194	213
Noise level	Standard mode		dB(A)			
	Silent mode		54			
Piping	Refrigerant	Gas	mm	Ø 19.1	Ø 22.2	Ø 25.4
		Liquid		Ø 9.5		
	Fuel gas		R 3 / 4"			
	Exhaust drain		mm			
Piping permissible length (actual / equivalent)		m				
Permissible height difference between indoor units		15				
Permissible height difference between indoor and outdoor units		+ 50 / - 40				
External dimensions	Height		mm			
	Width		2.077			
	Depth		1.400			
Weight (standard / renewal)		Kg				
		565 / 570				
Connectable indoor units	Number (standard / cold district)		20 / 13			
	Capacity		%			
		50 – 200 standard / 50 – 130 cold district				

NOTE:

---

# AISIN

*Geared up for the future*



0051  
0497  
05/004/8

**Made in Japan**



**ANIMA®**



Distributore Unico Europeo - *European sole distributor*

**TECNO CASA**  
CLIMATIZZAZIONE

Via Manzoni, 17 - 60025 Loreto (AN) - Italy  
Tel. +39 071 977805 - Fax +39 071 976481  
[www.tecno-casa.com](http://www.tecno-casa.com) - [www.aisin.it](http://www.aisin.it)  
[info@tecno-casa.com](mailto:info@tecno-casa.com)